



70413

PIRATES







[LEGO.com/brickseparator](http://LEGO.com/brickseparator)



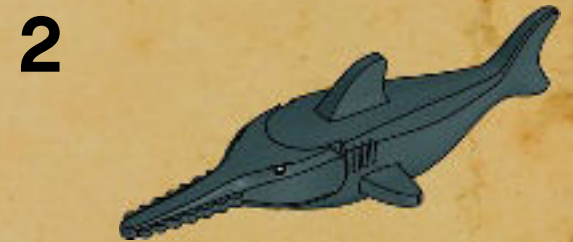
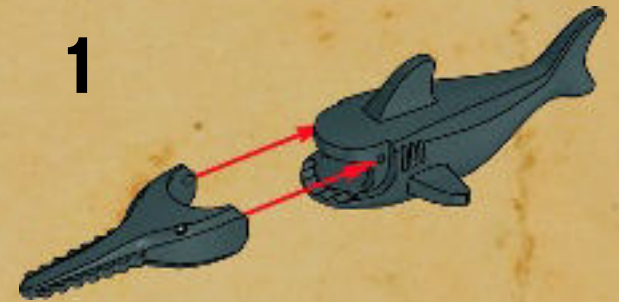
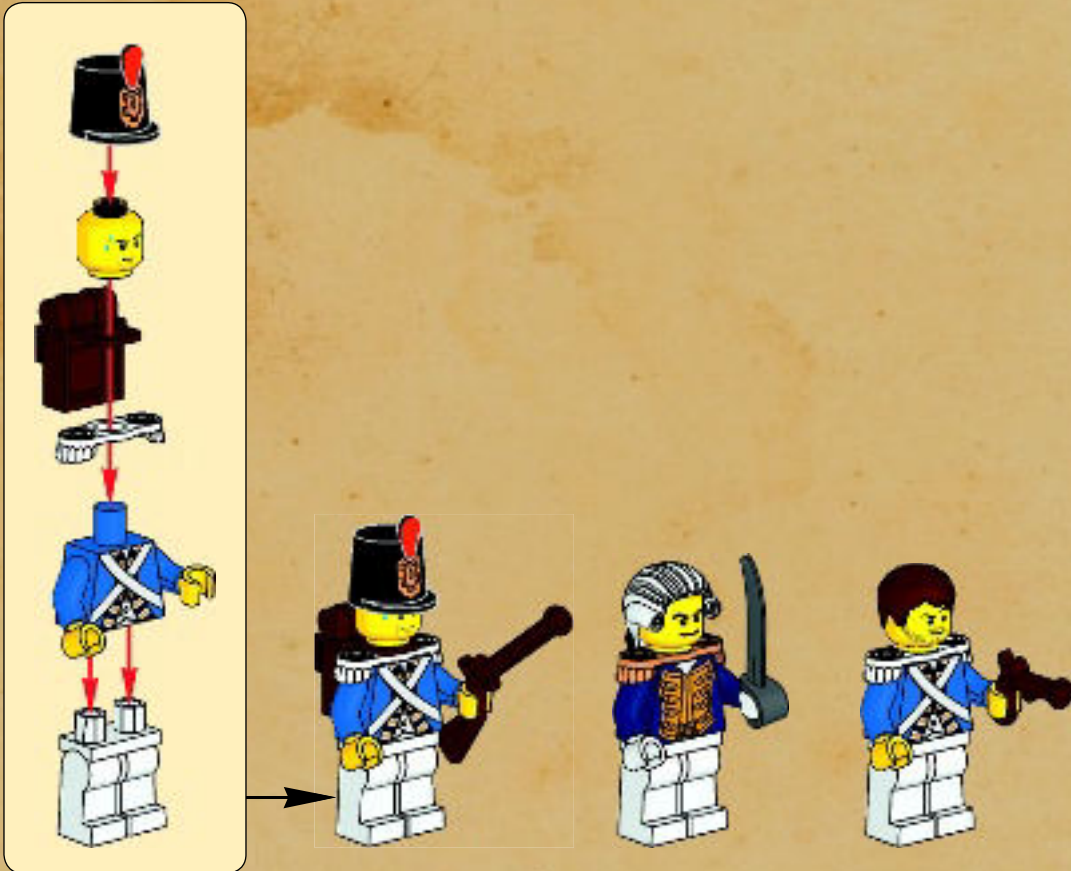





1



2



3

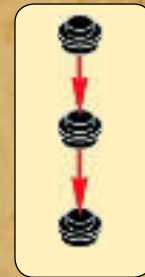





4

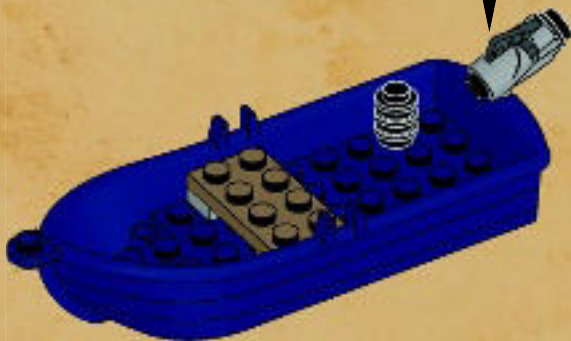
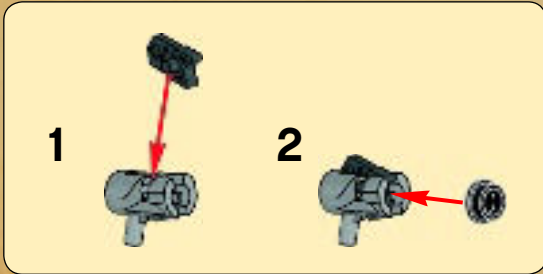

5

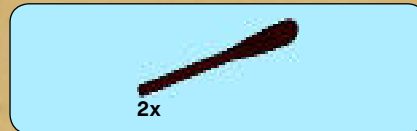
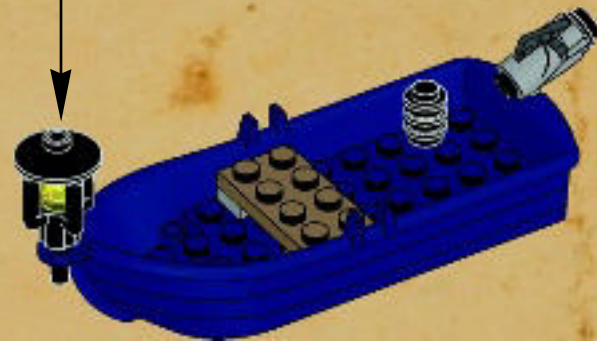
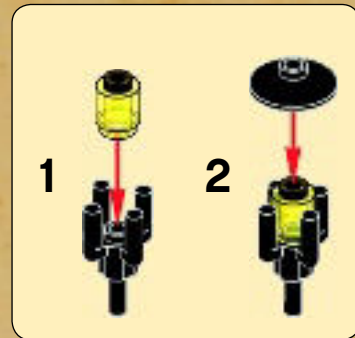

6

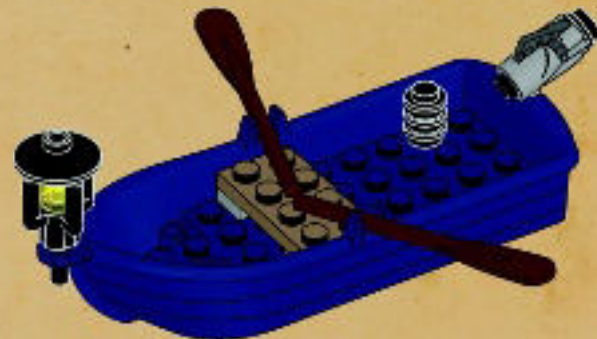



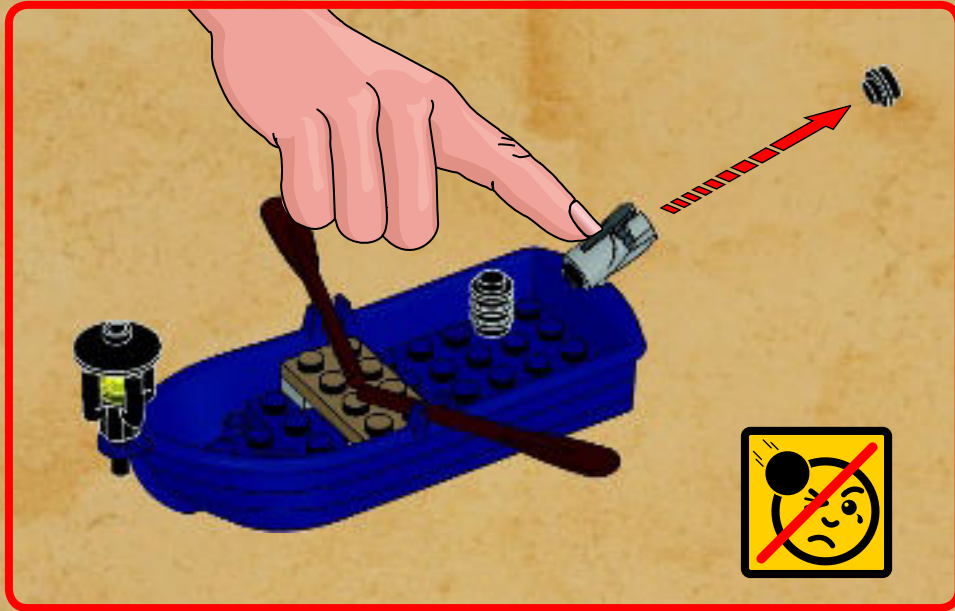



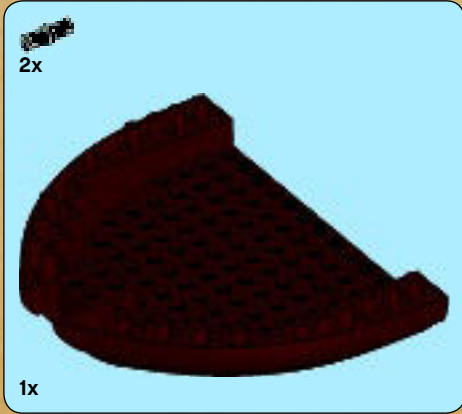

1

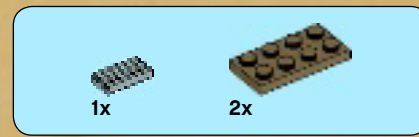
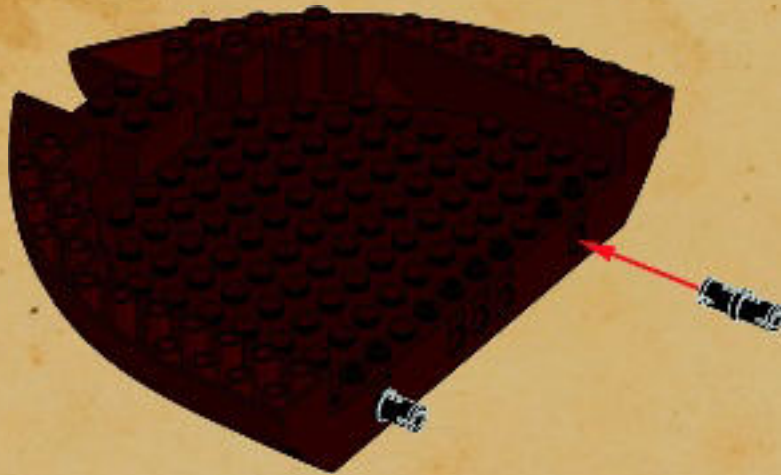

2

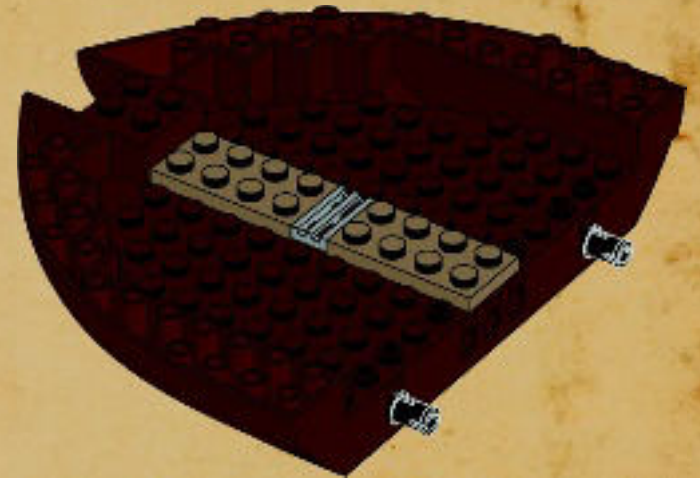





3

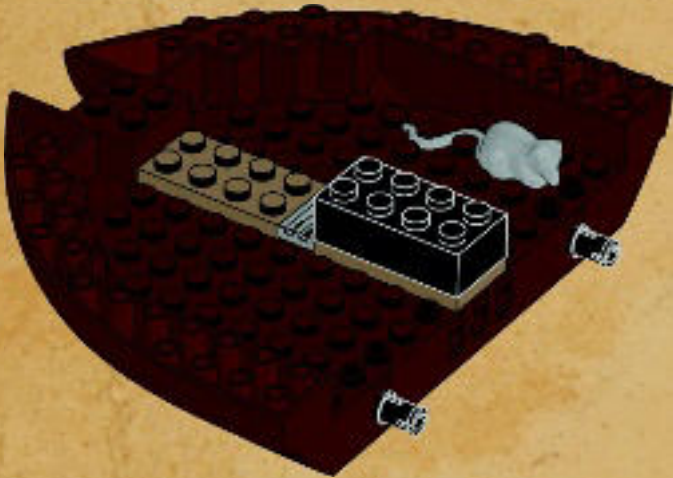

4

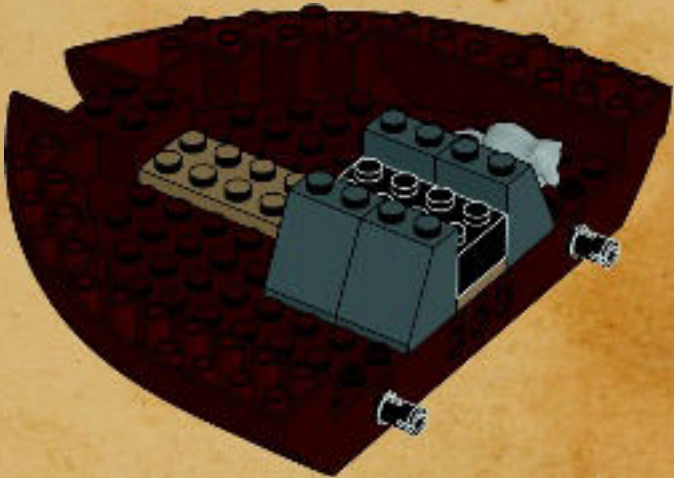



5

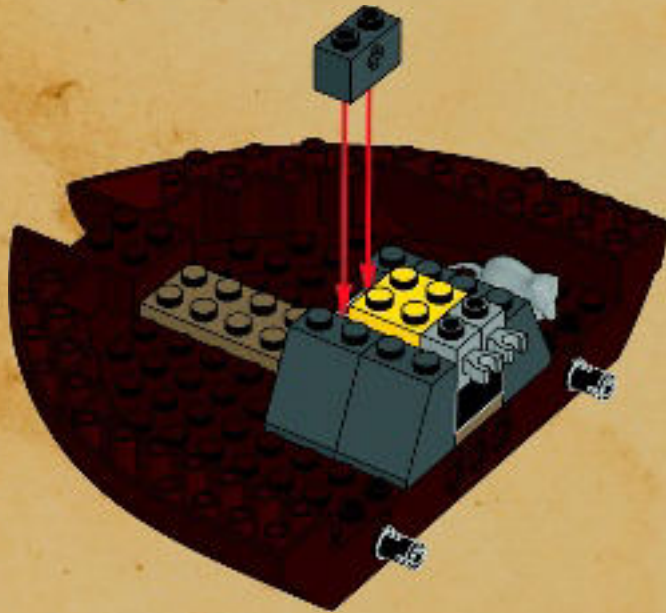

6

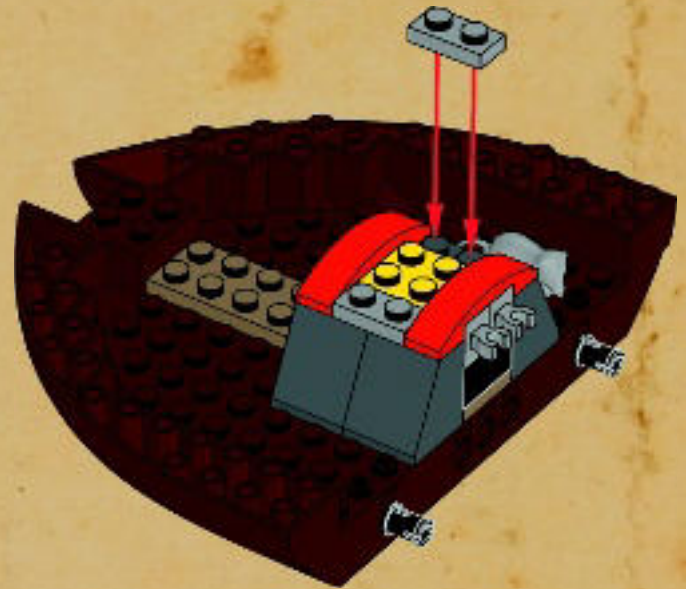



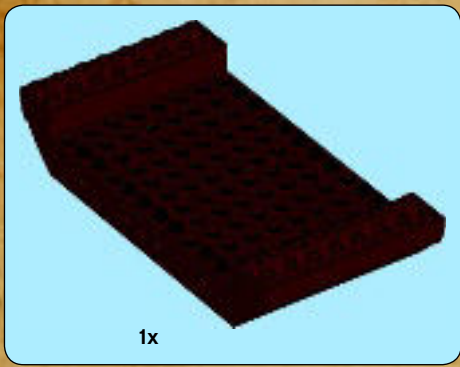

7

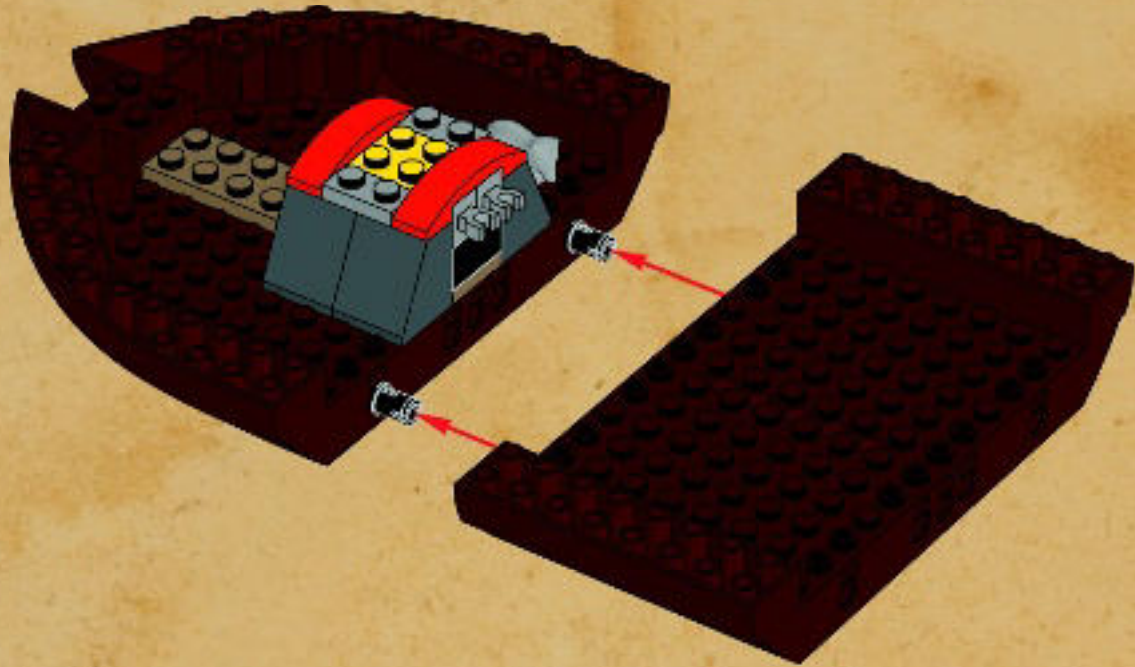

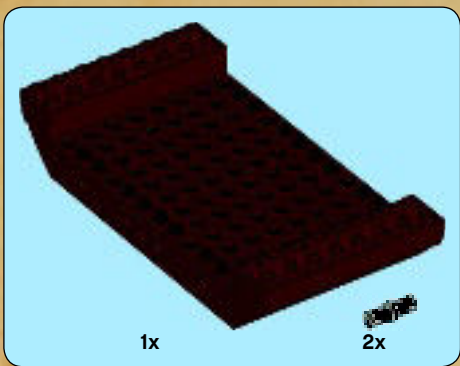

8

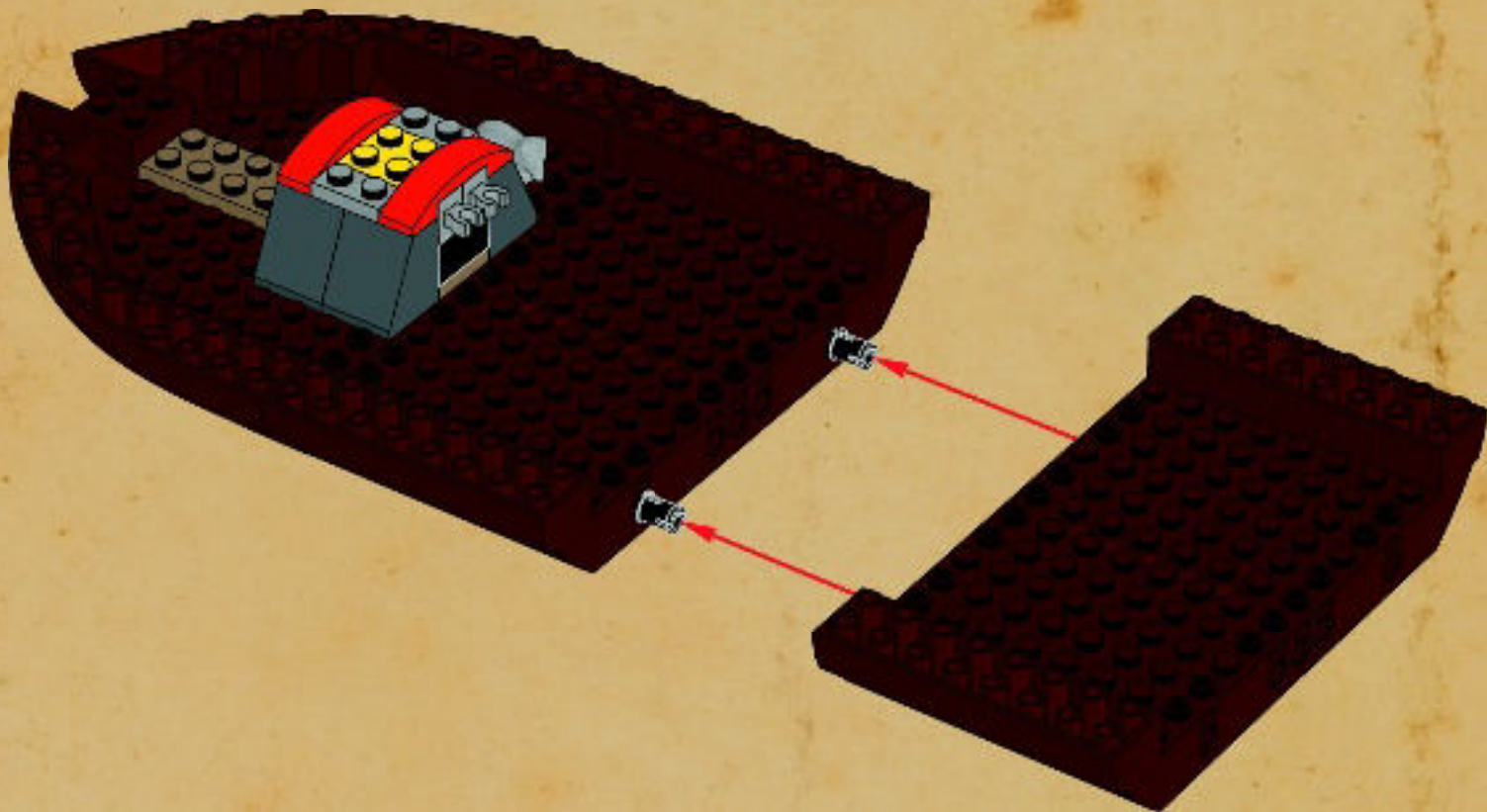



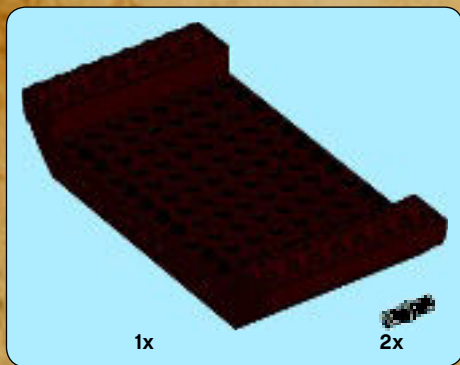

9

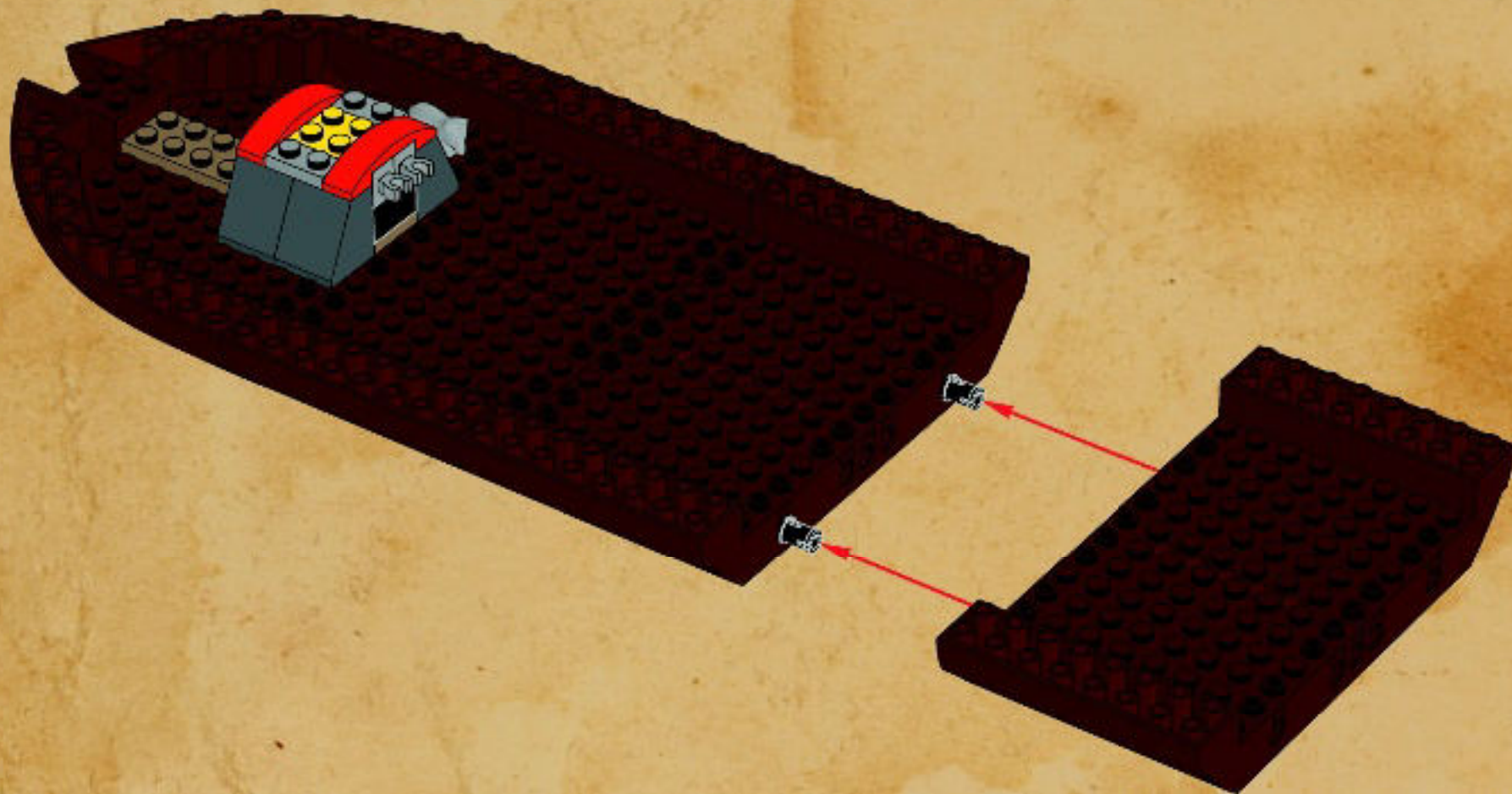



10

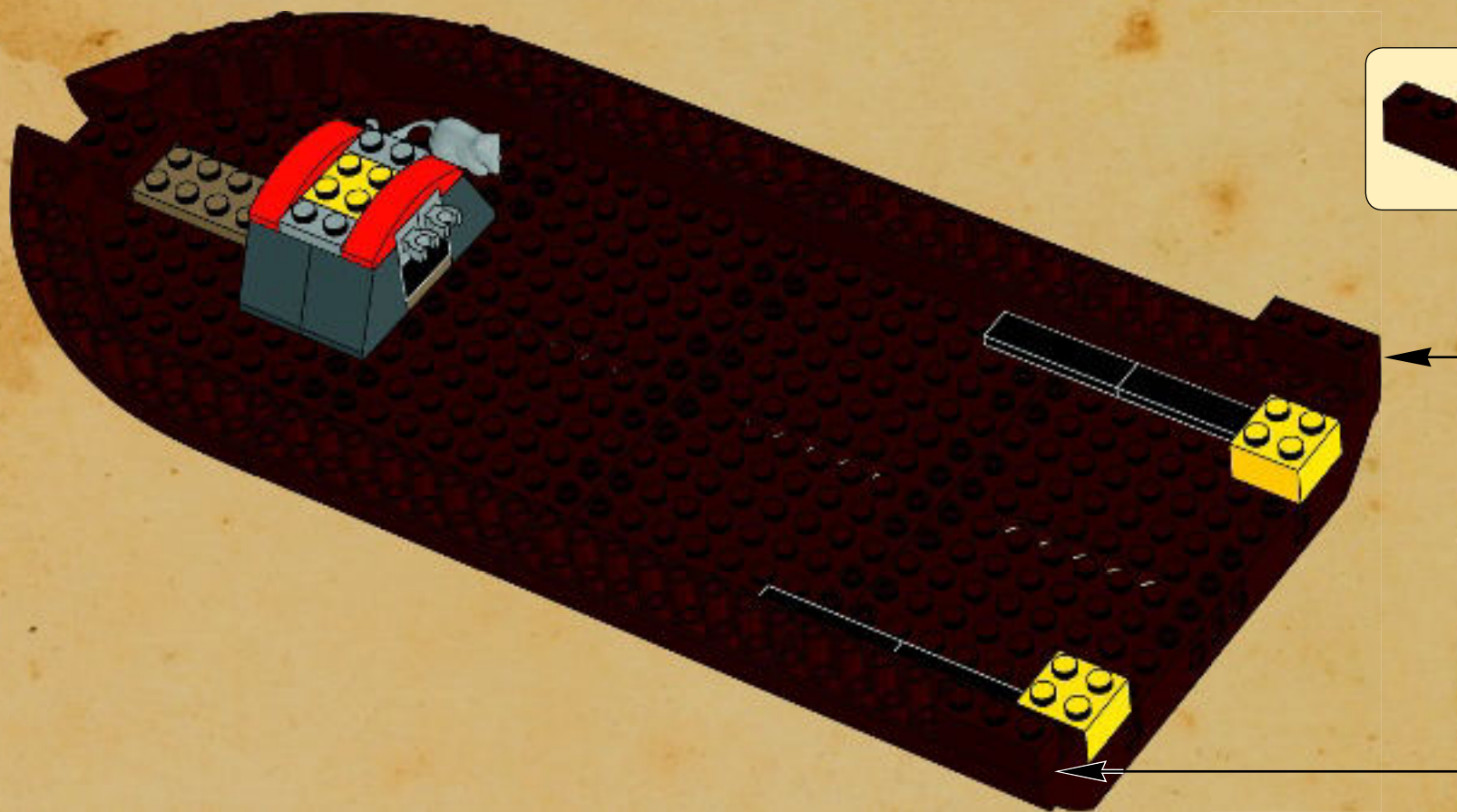



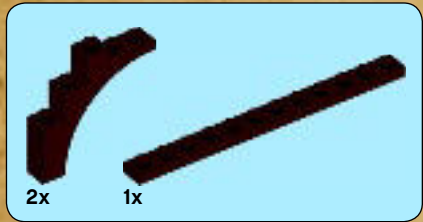

1

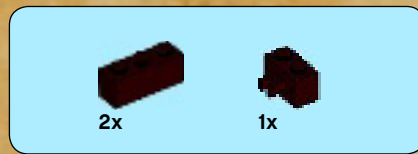

2





3

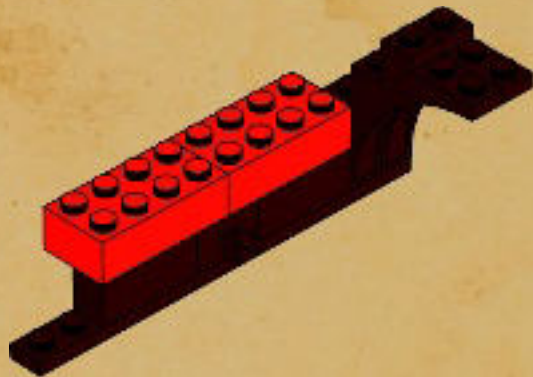

4

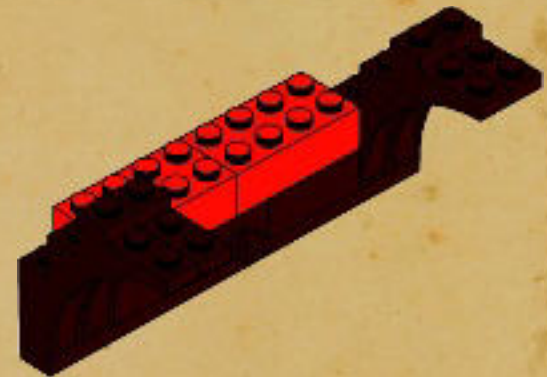



11

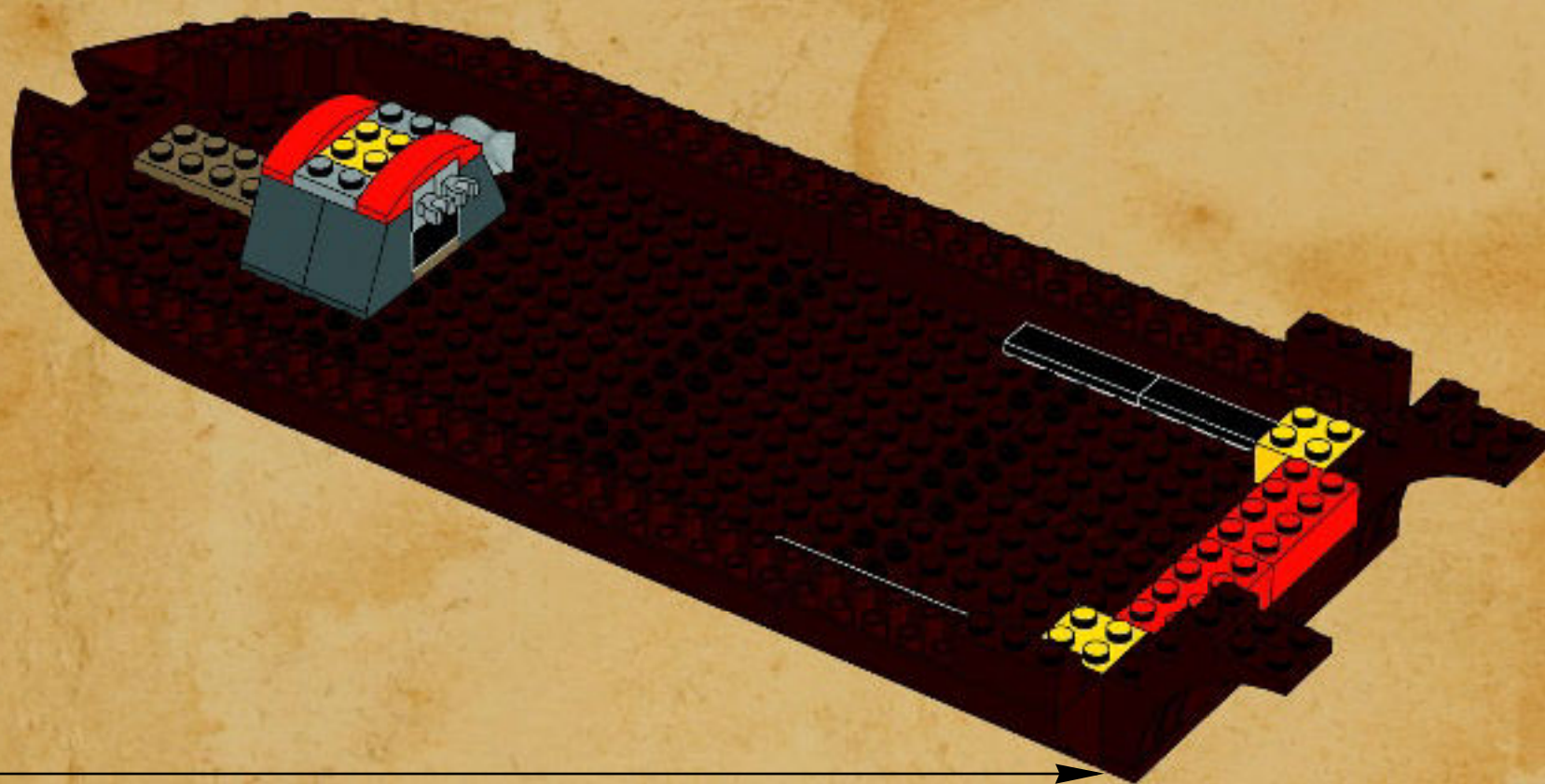



12

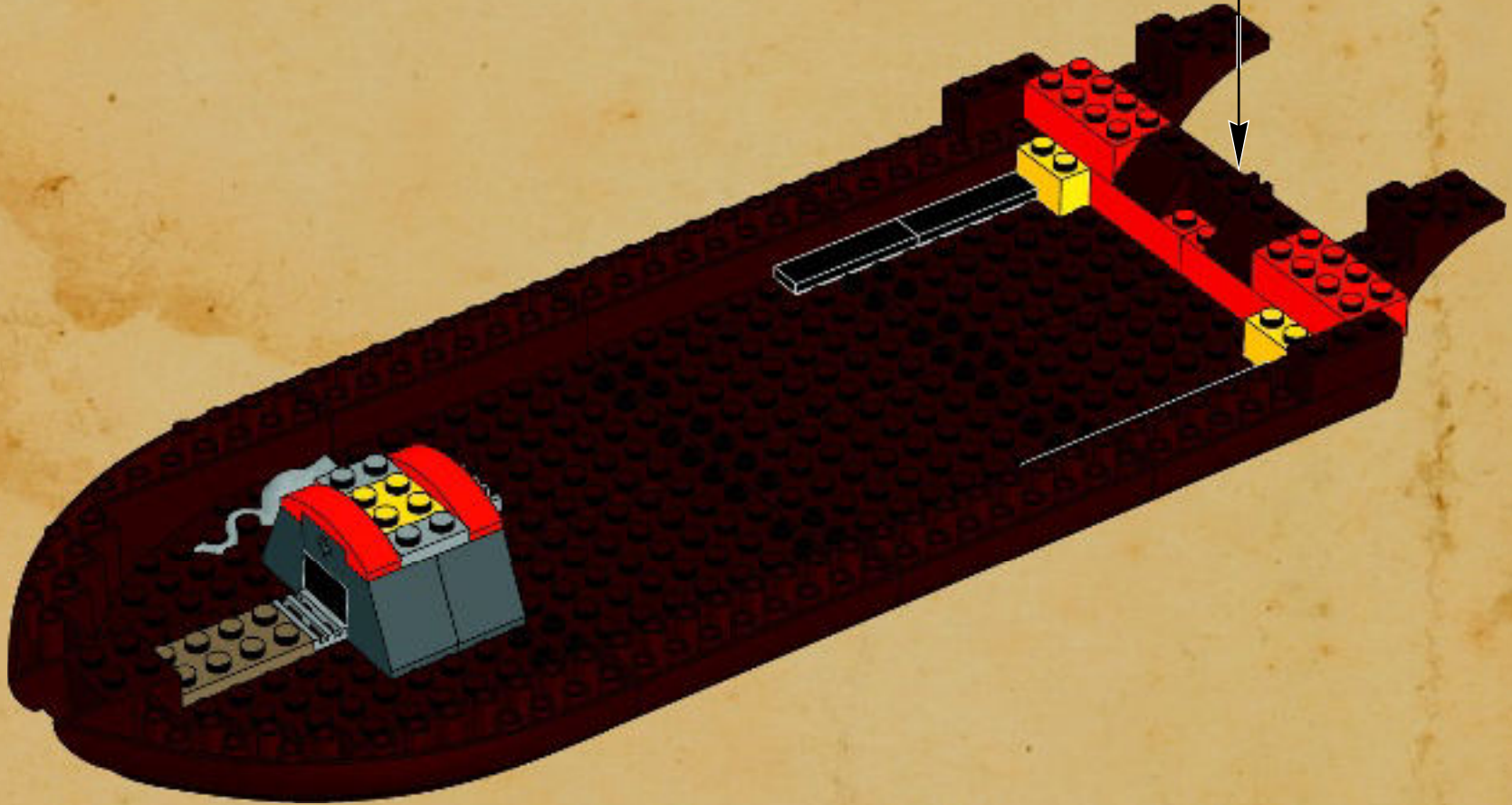



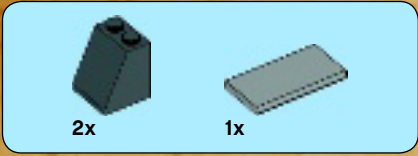

2x

1x

# 13

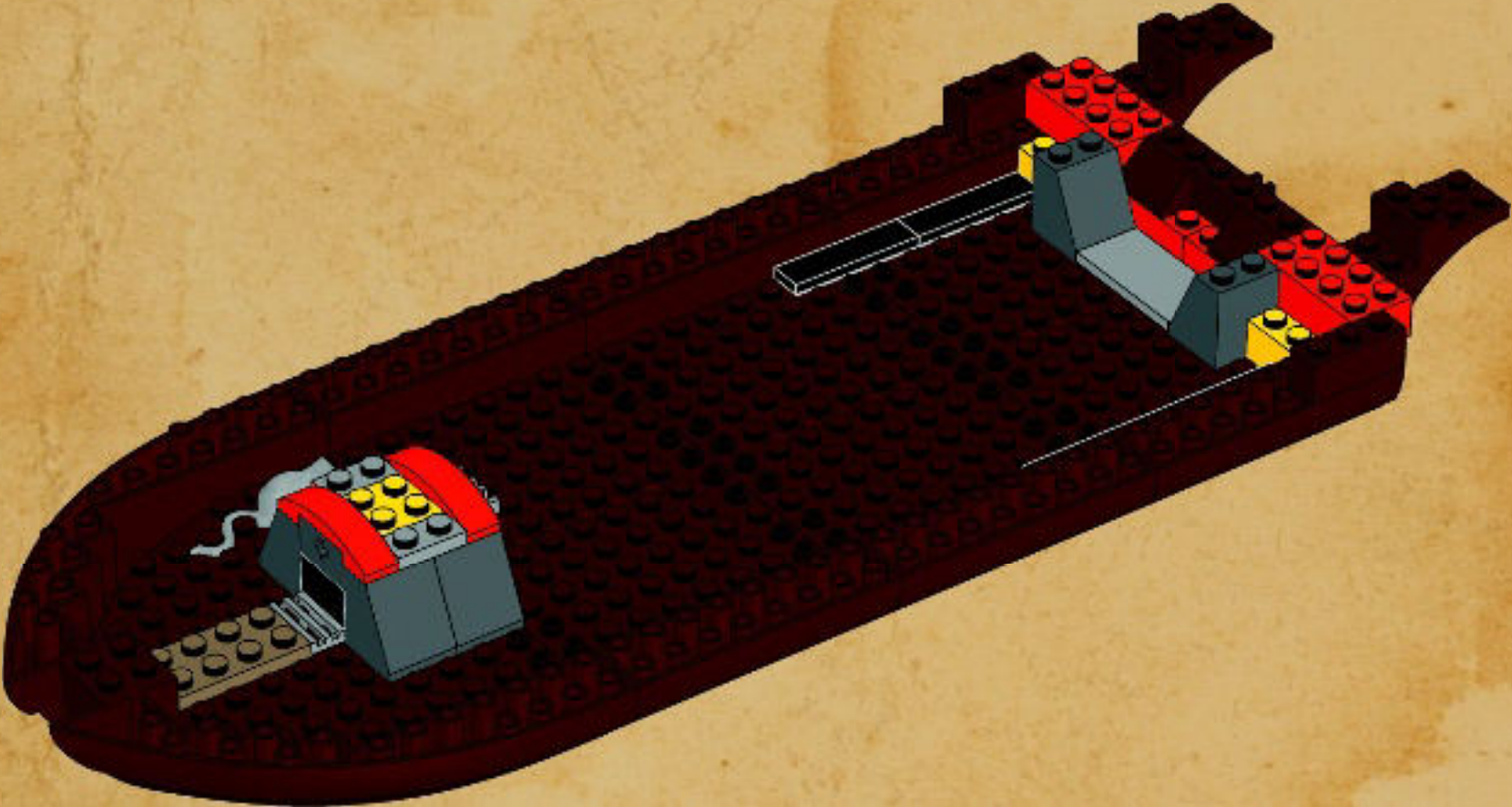

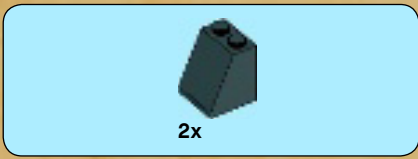

14

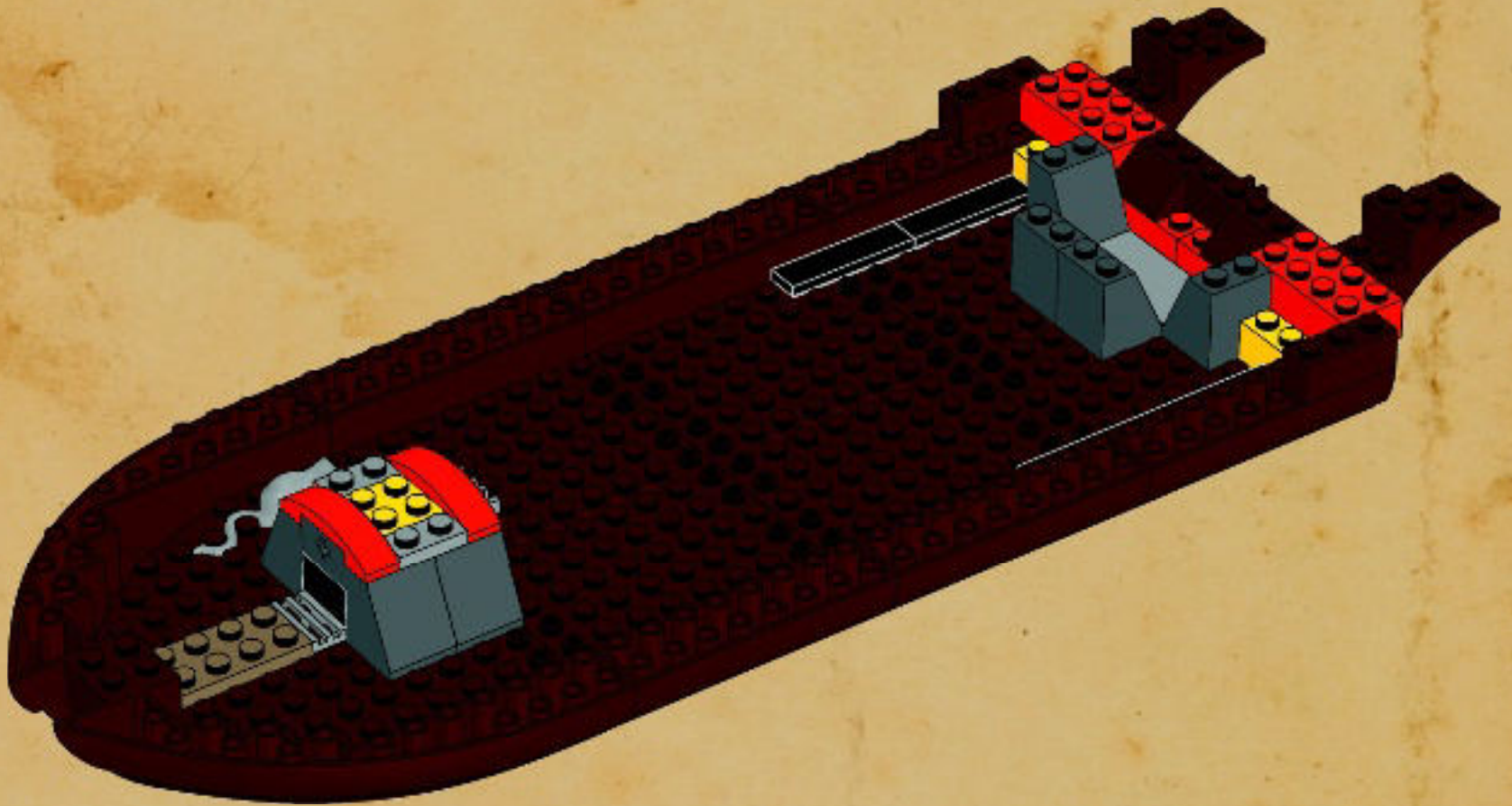





15

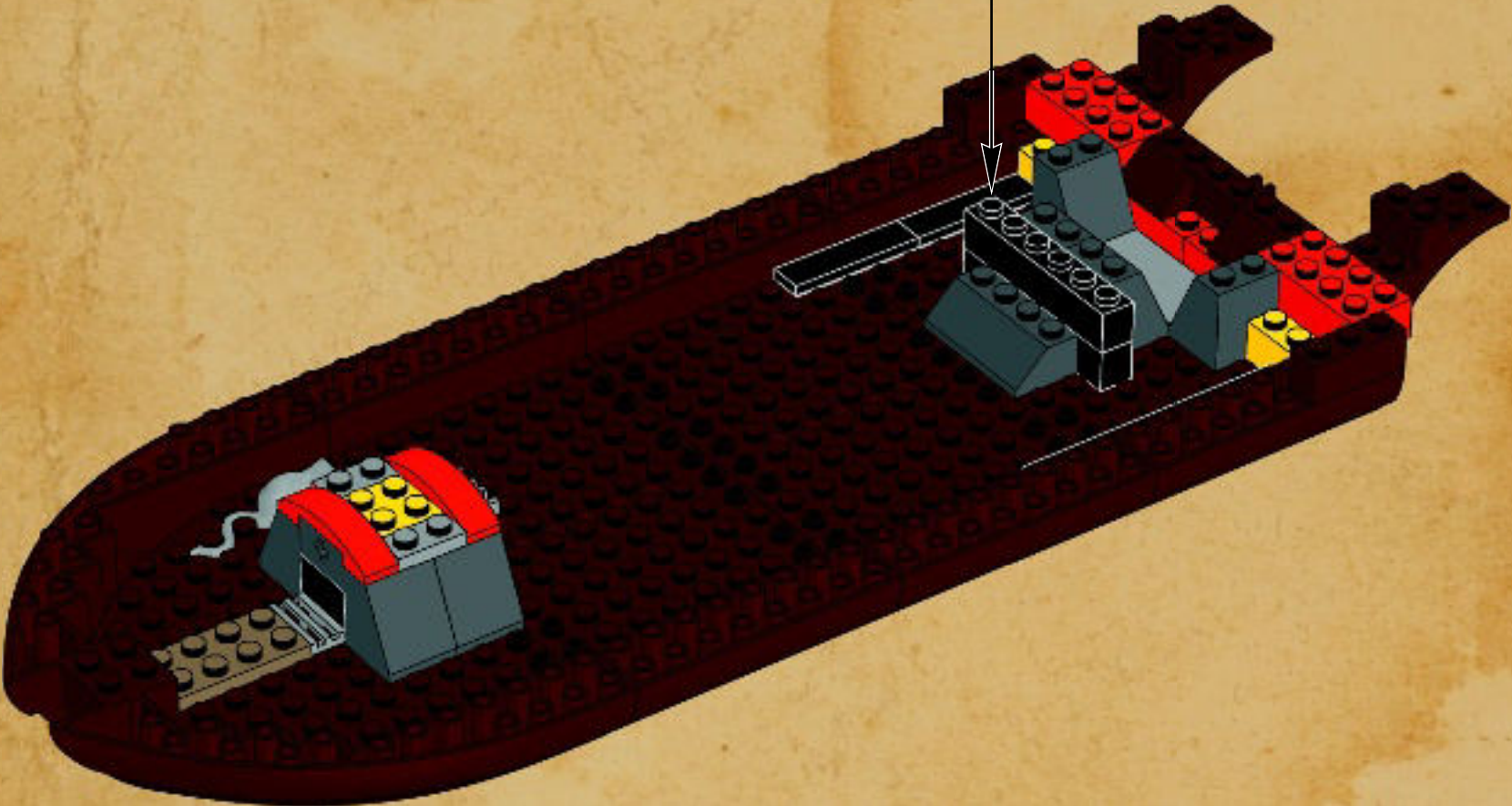
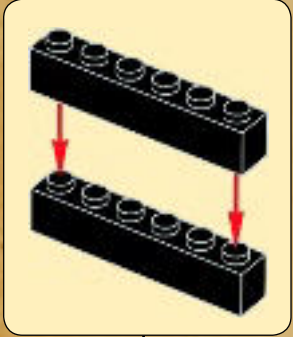



16

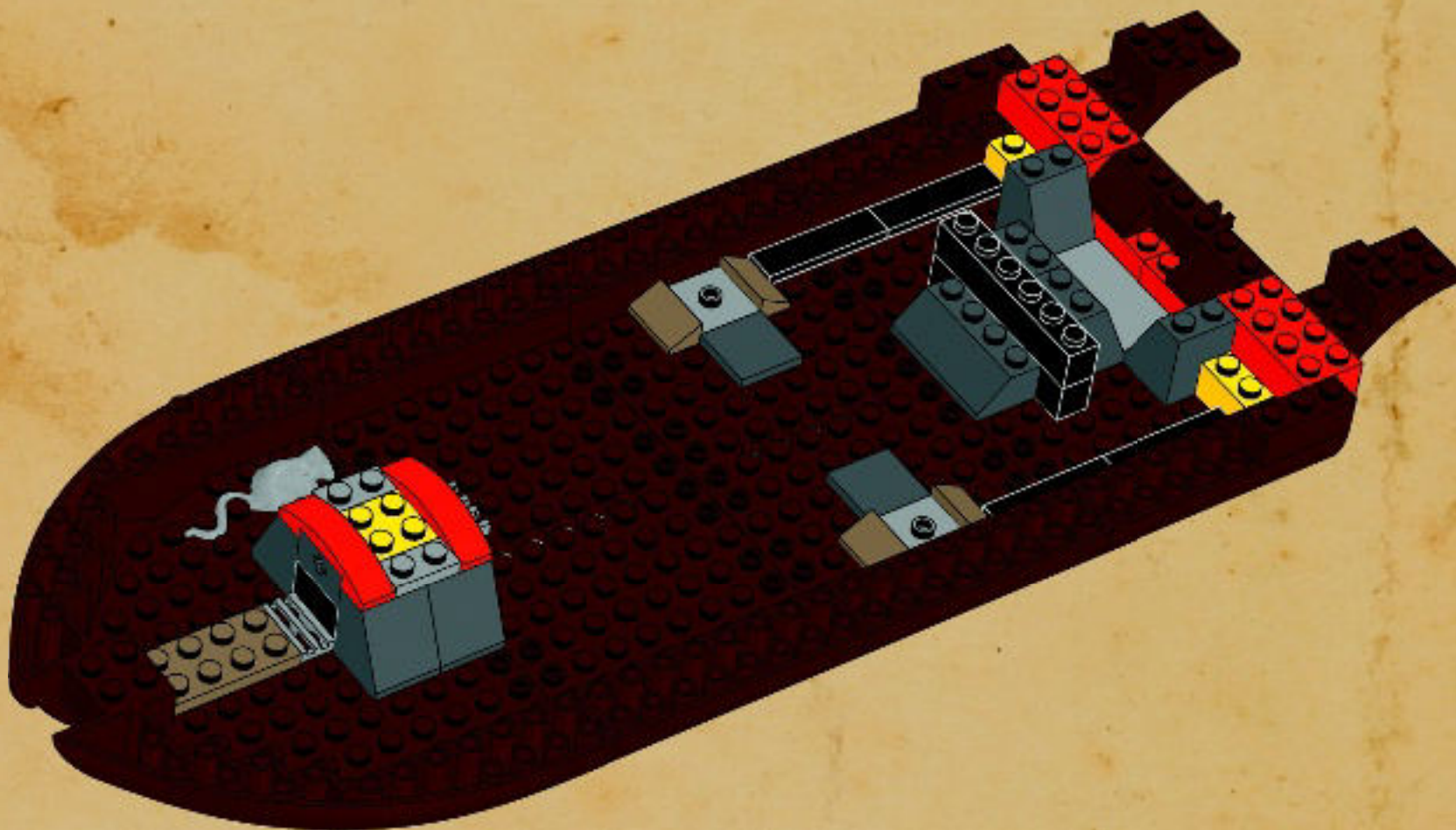



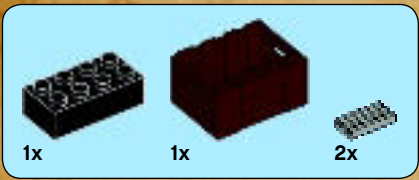

17

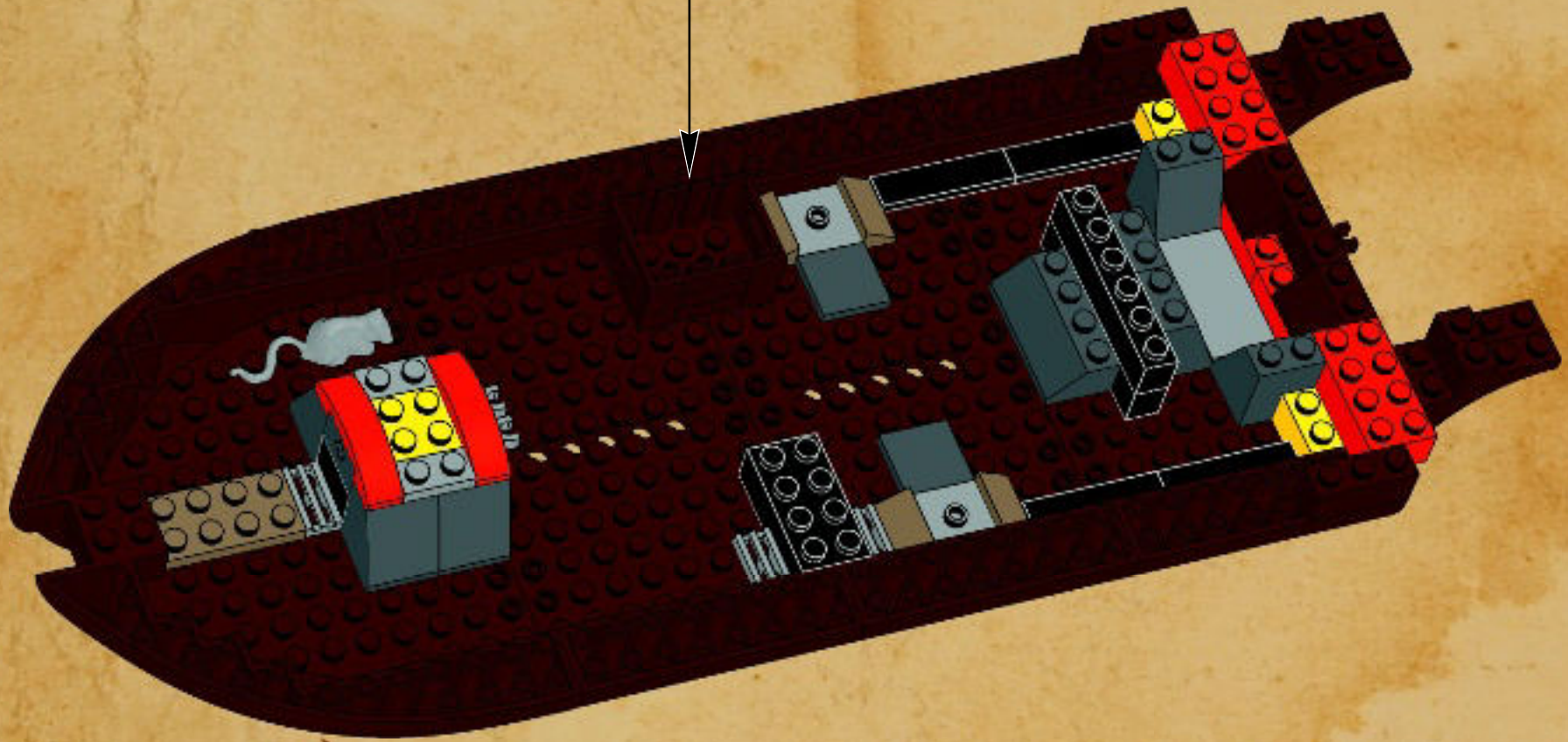





18

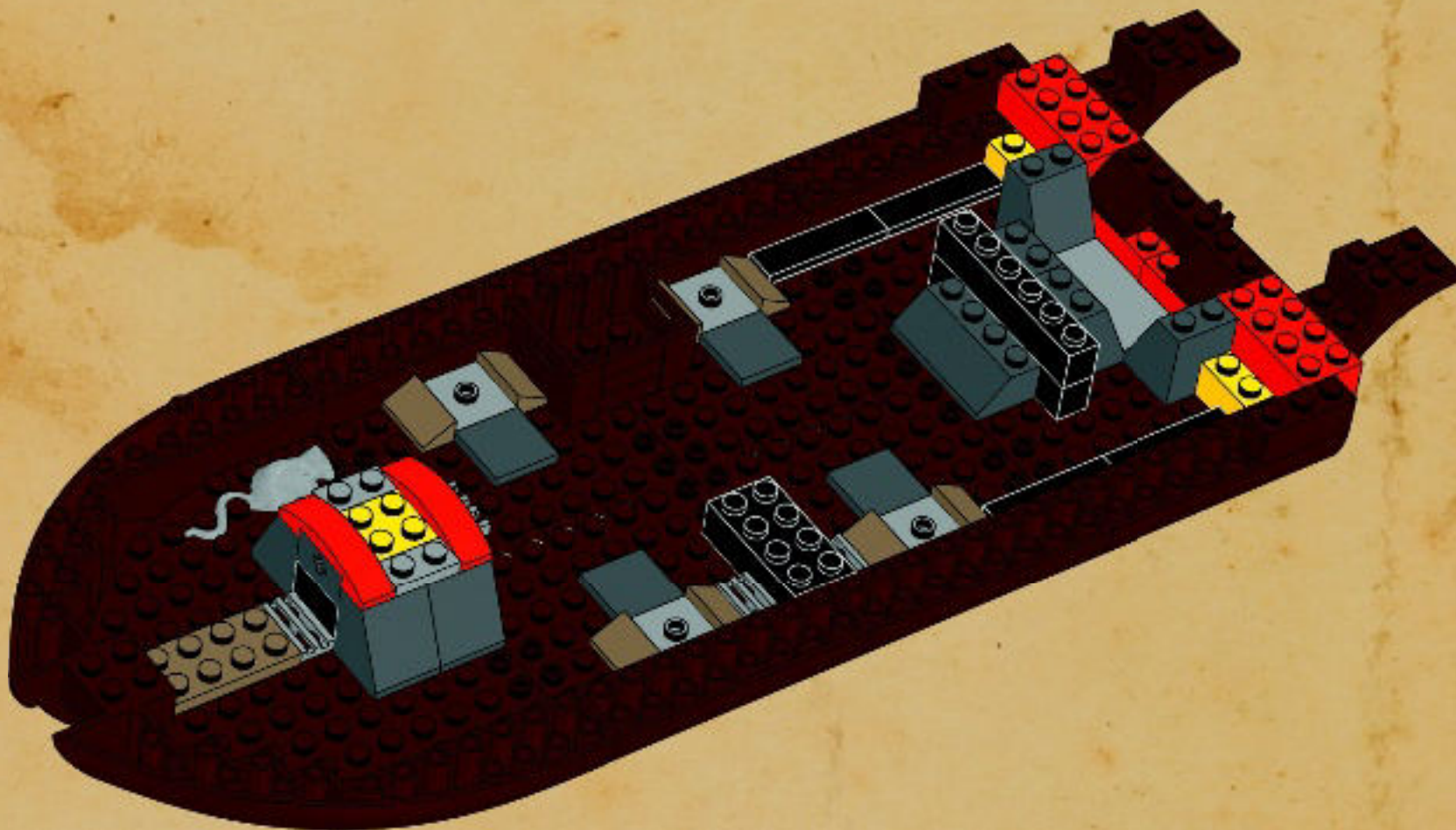





19

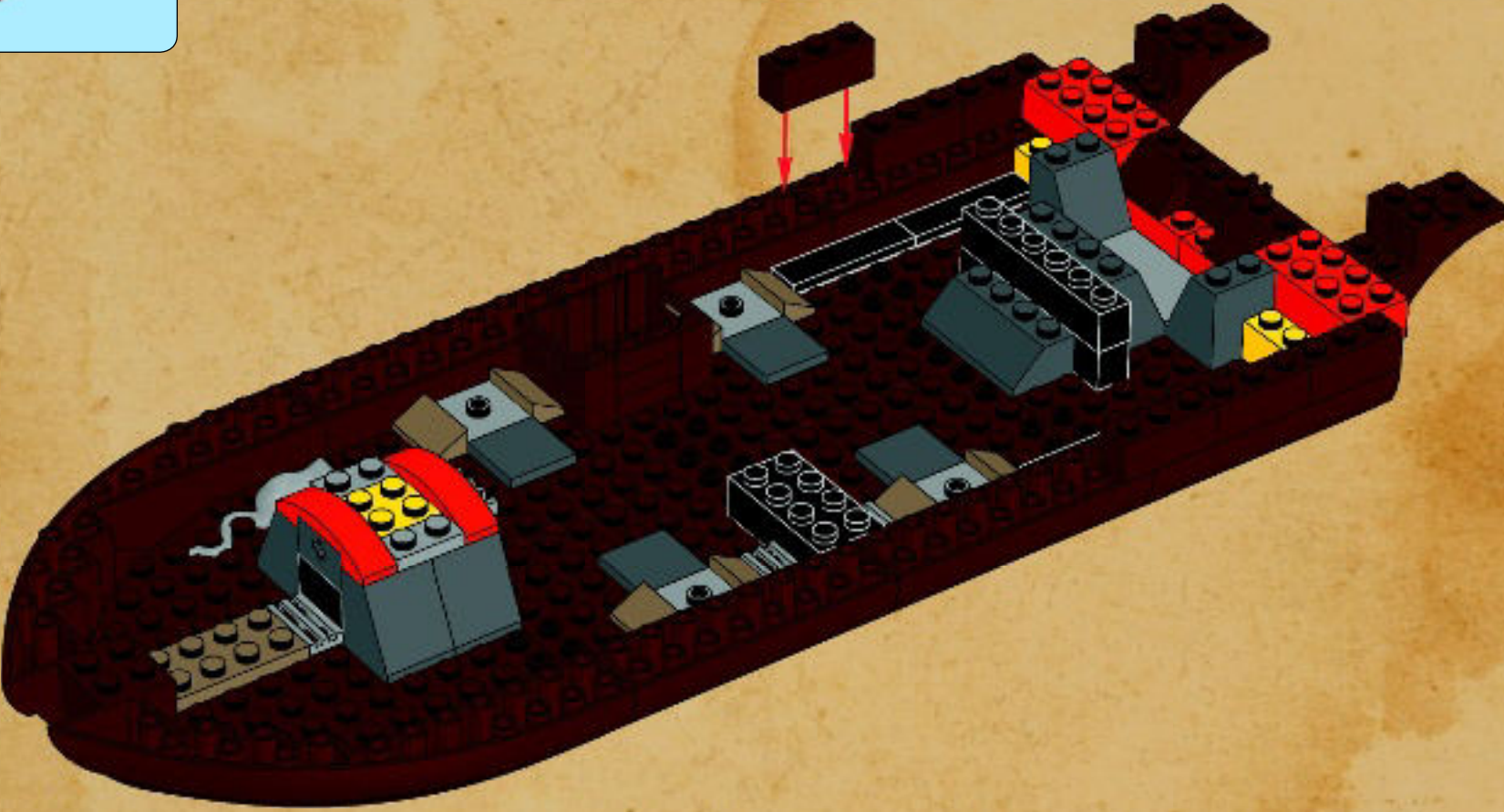

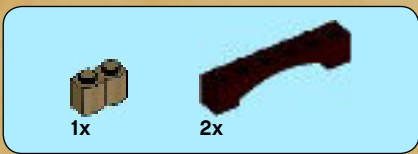

20

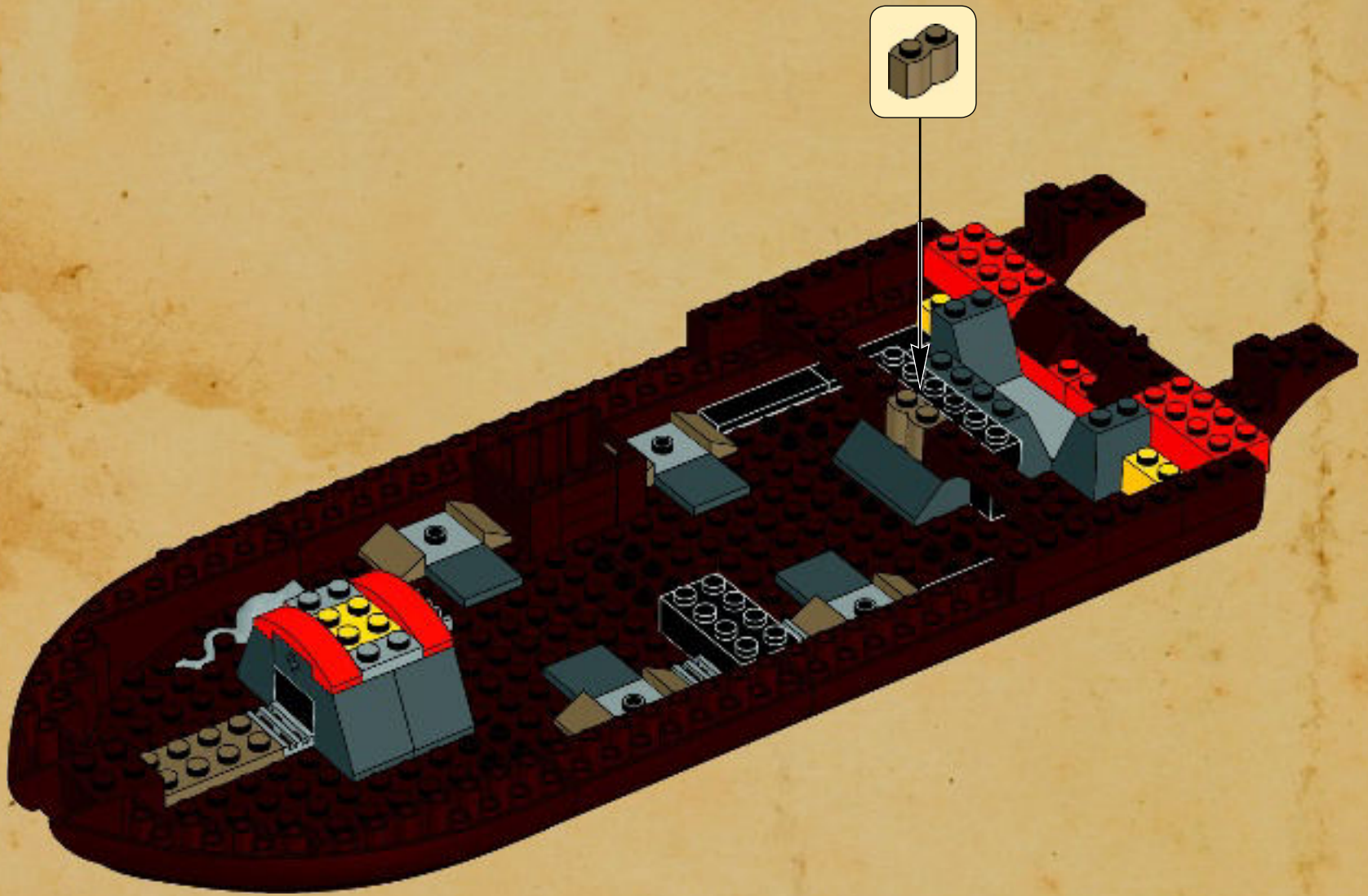



2x  2x  2x 

21

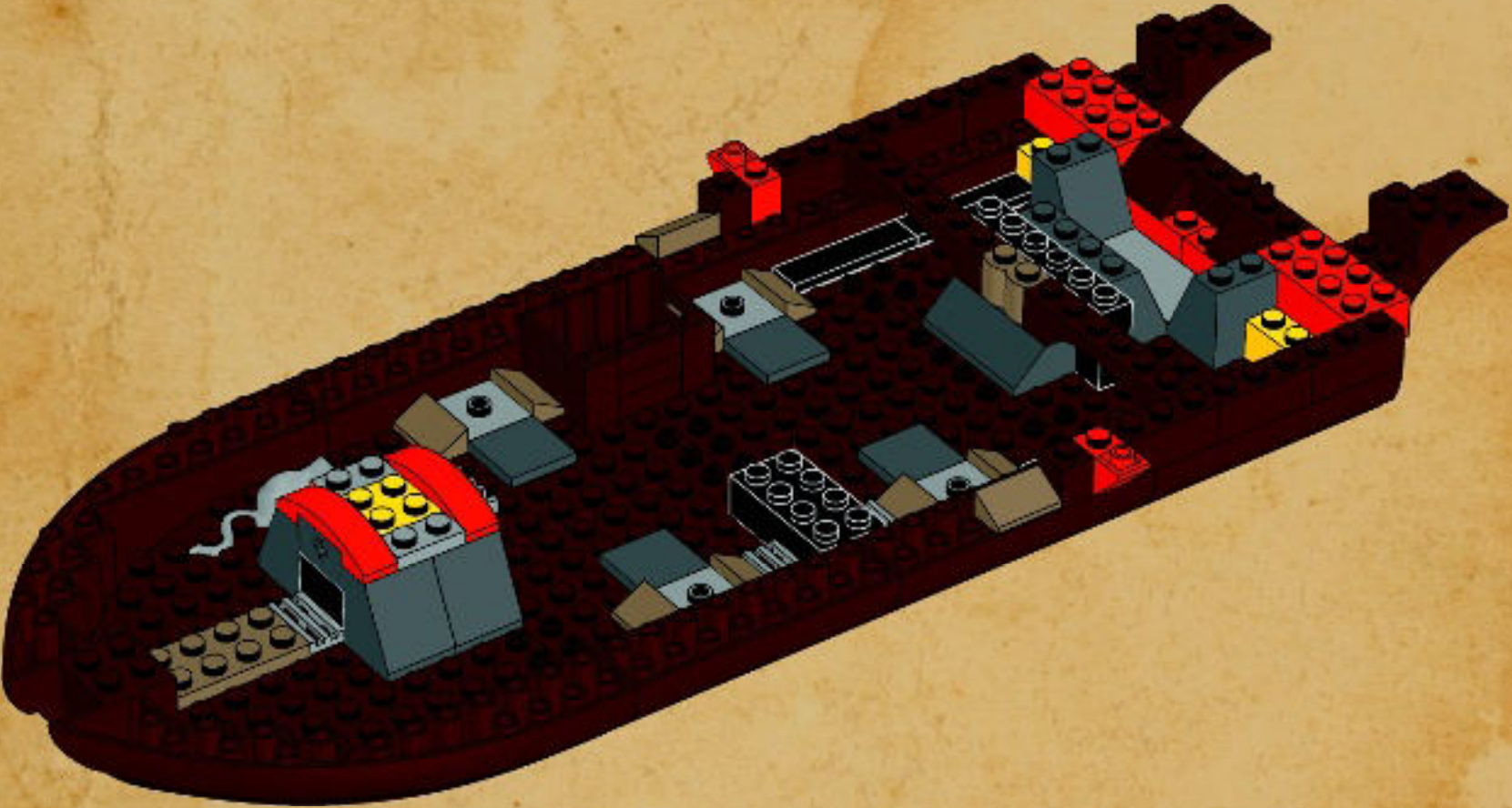

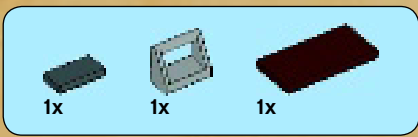

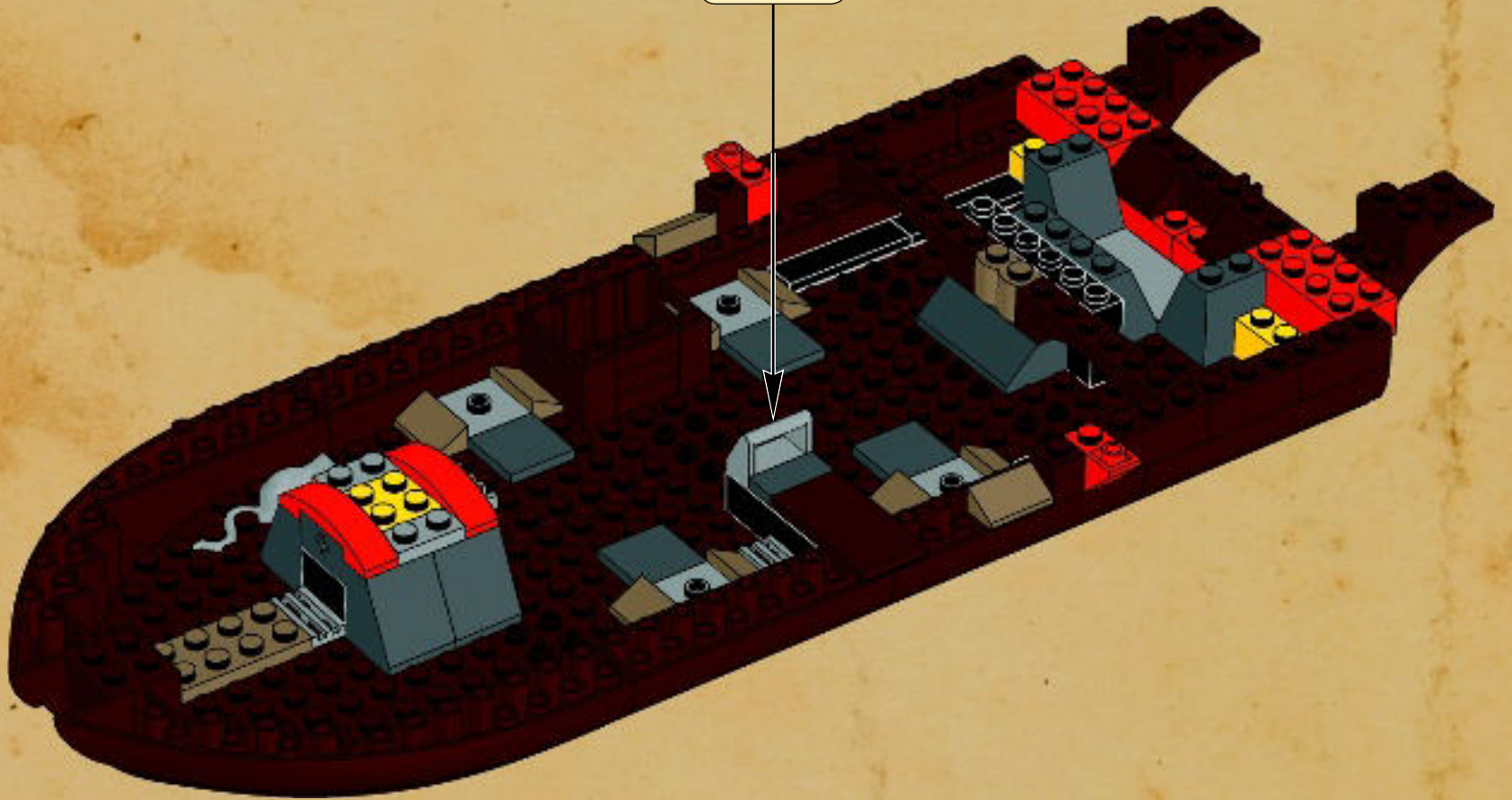
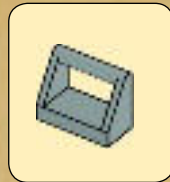

22





4x  1x 

23

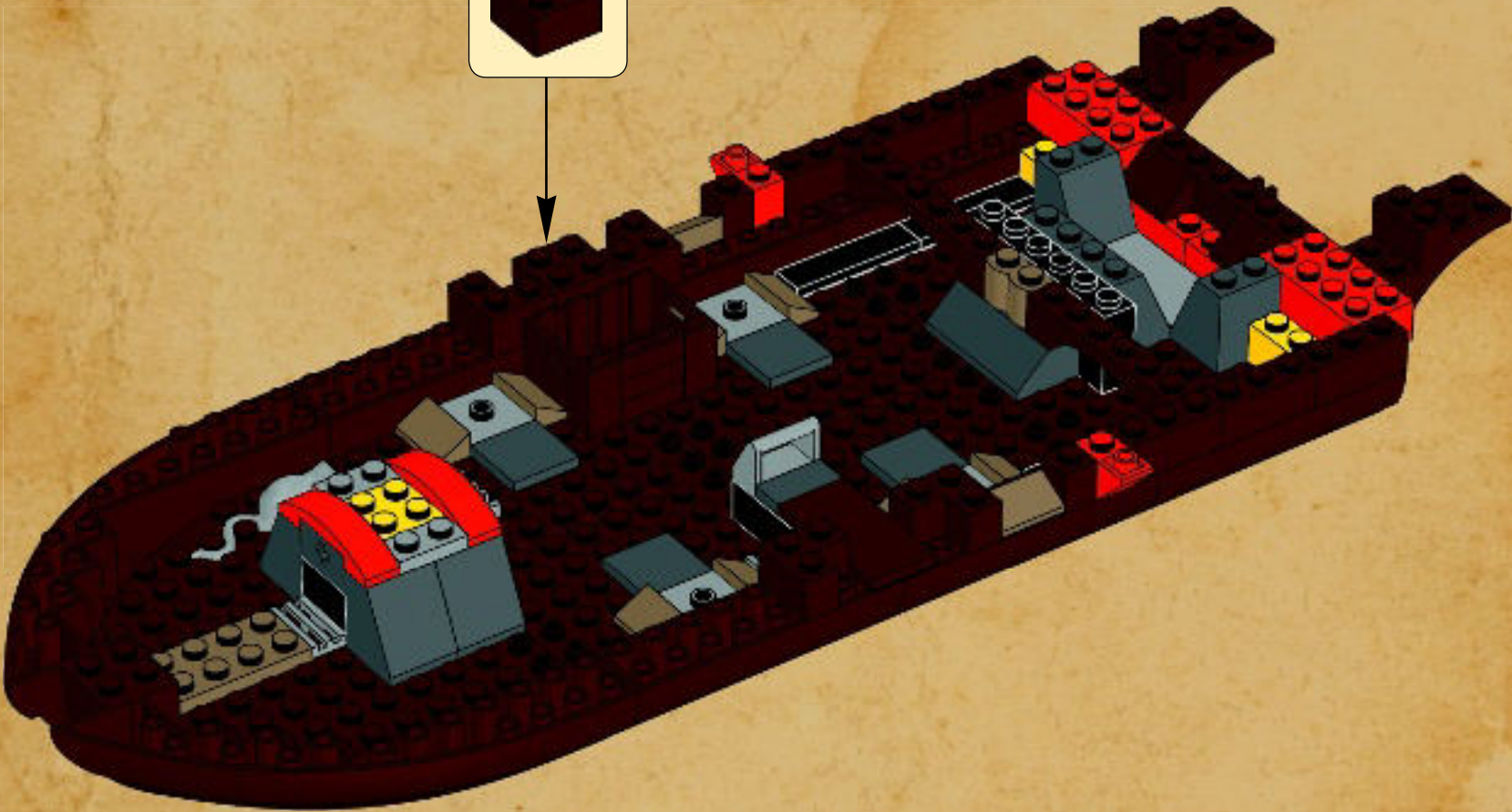



4x

24

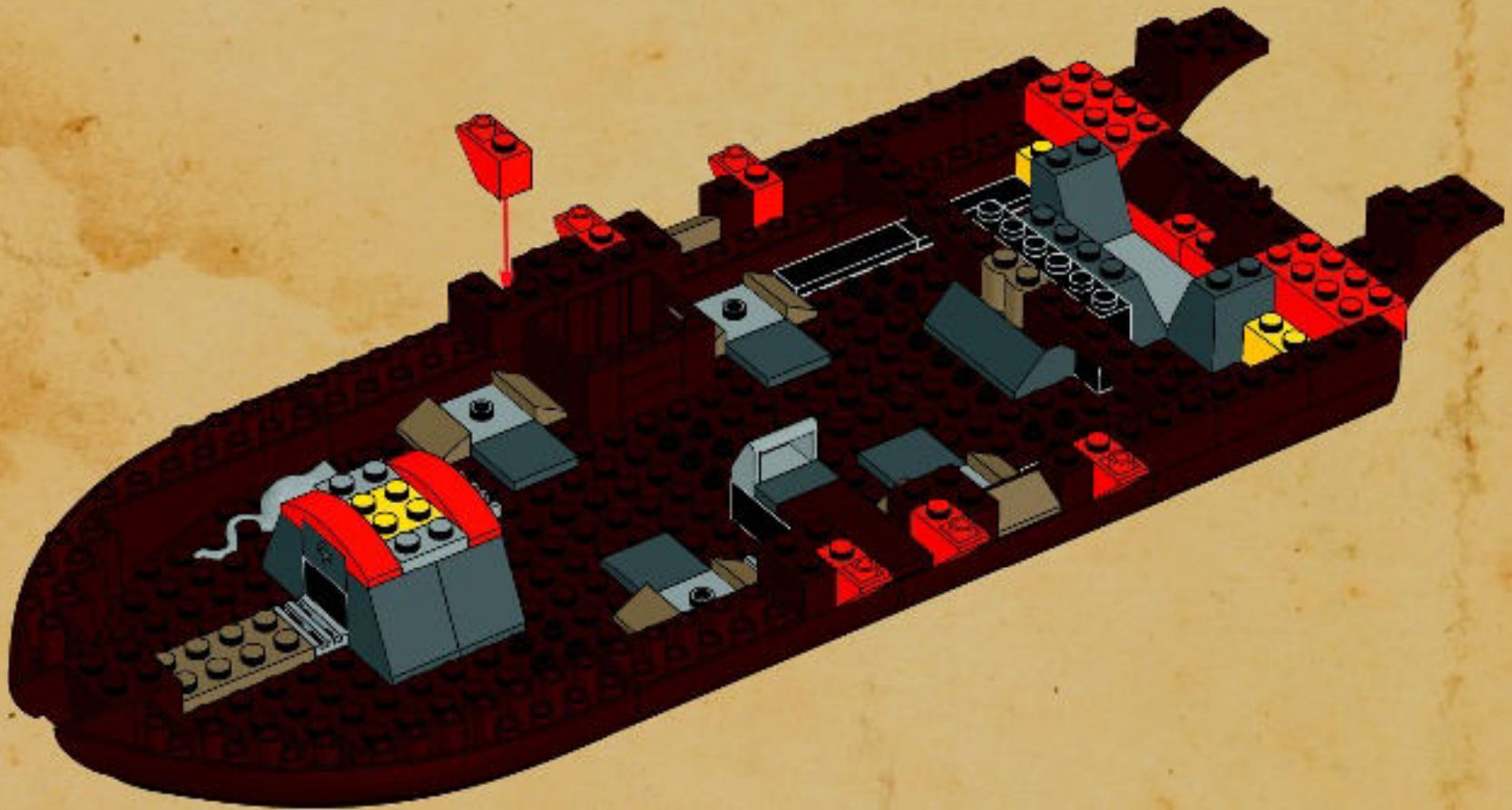



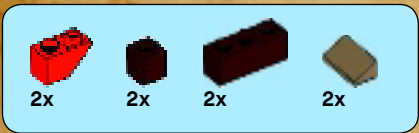



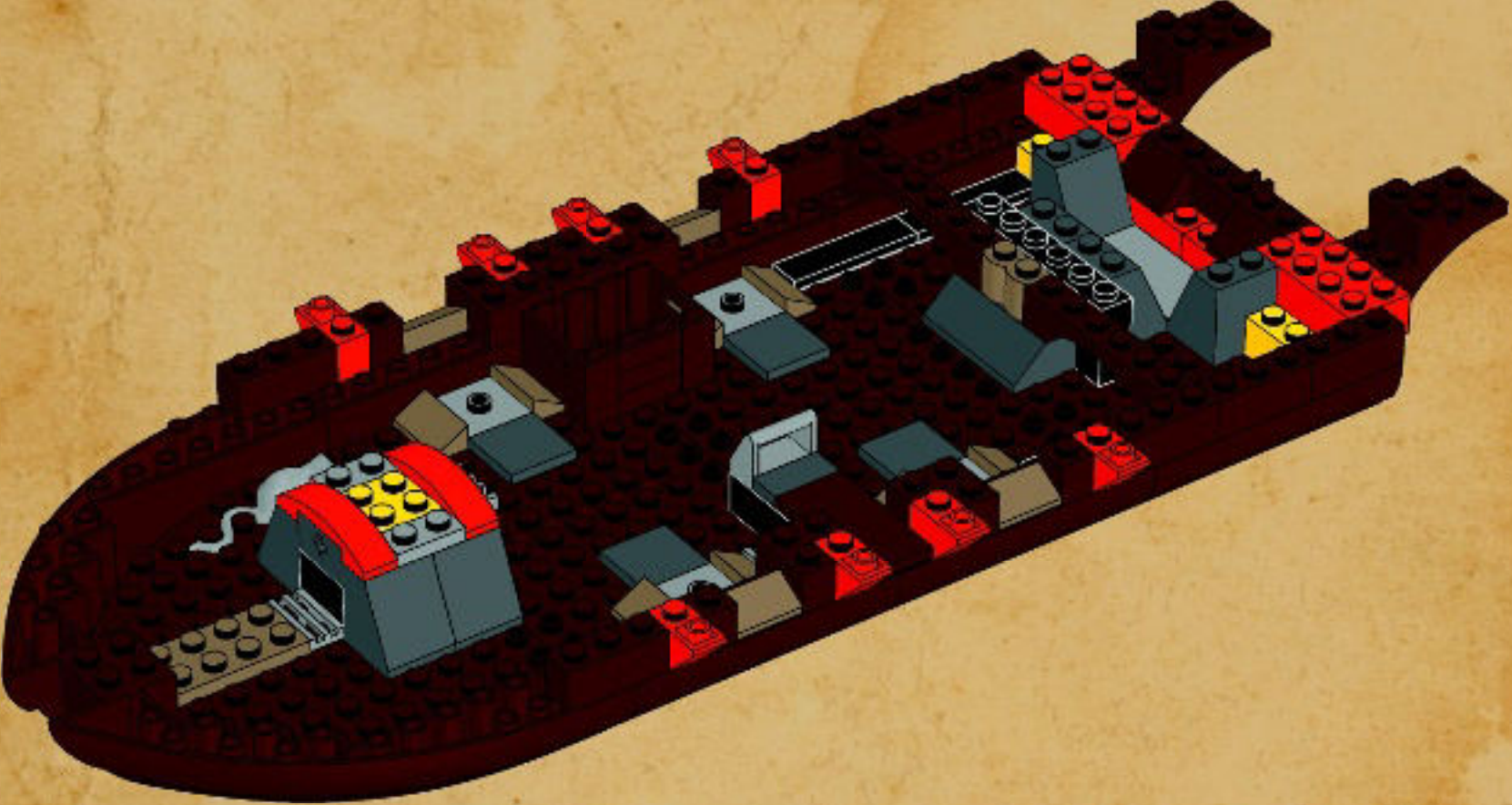

25





4x  2x 

# 26

1  

2  2x

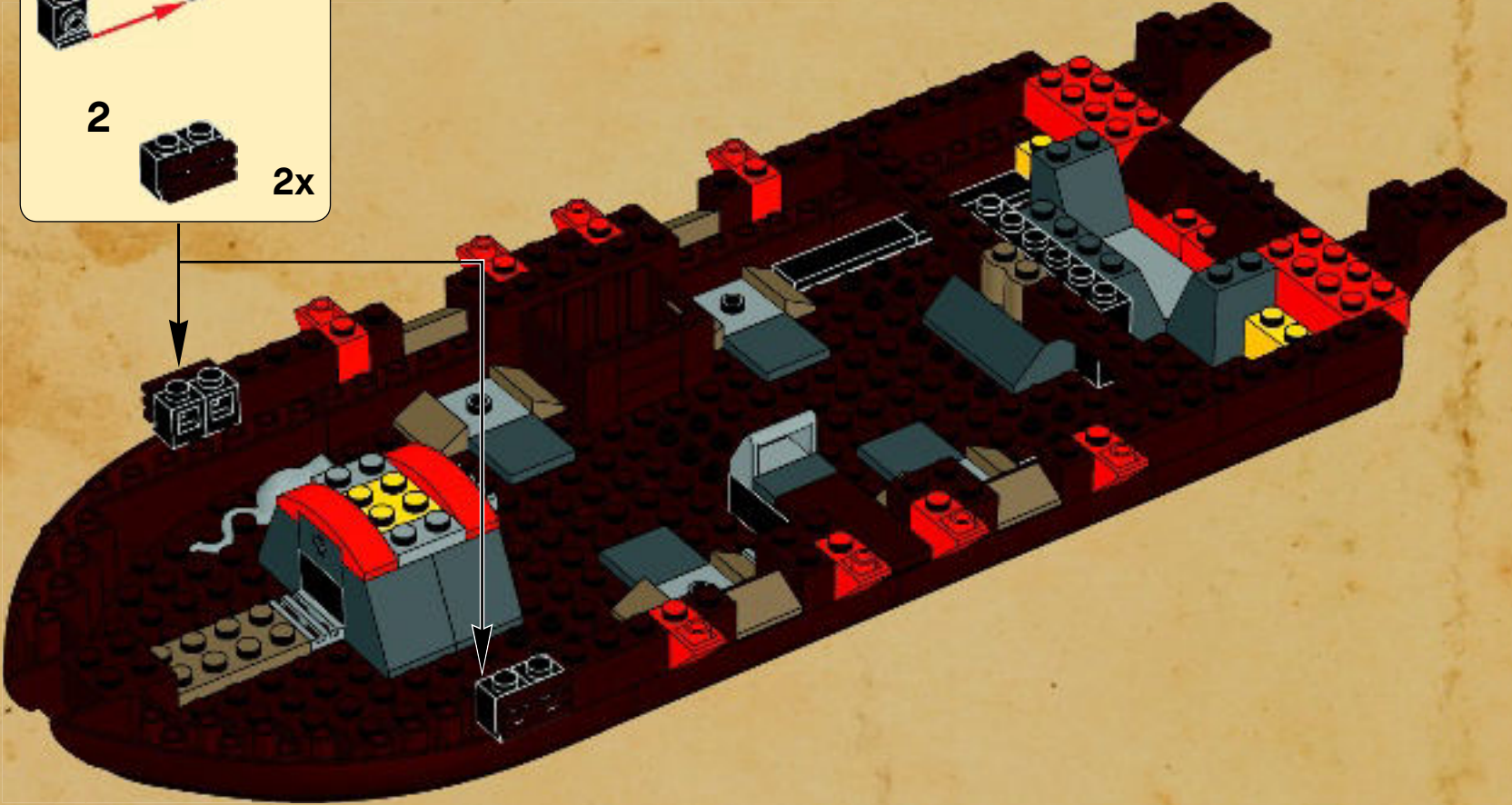



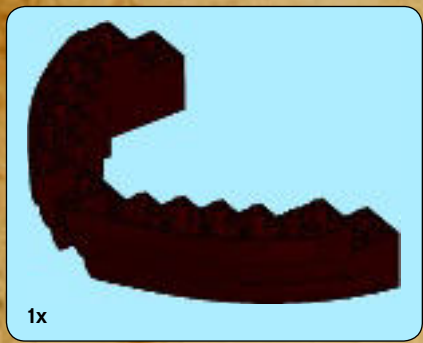

27

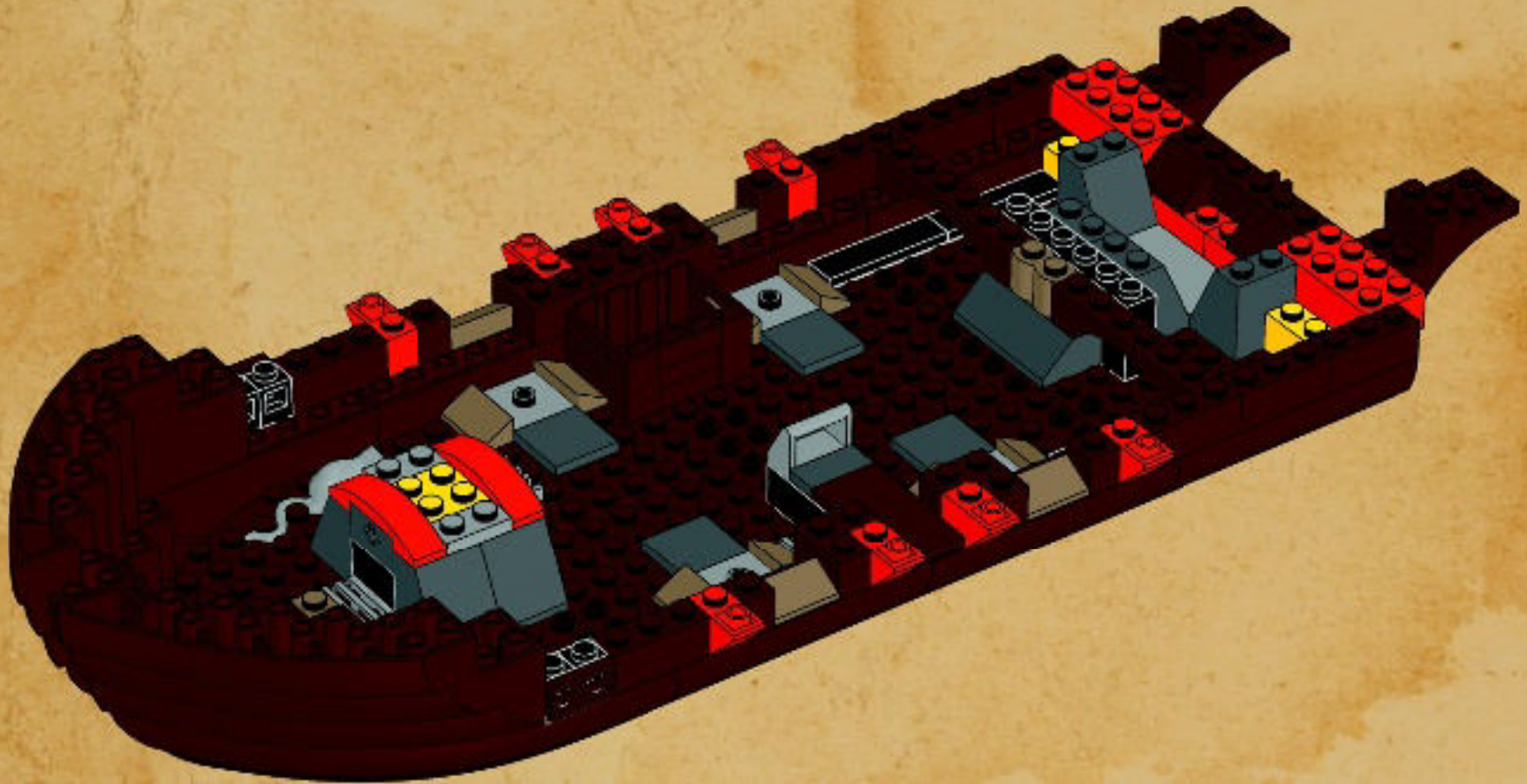





28

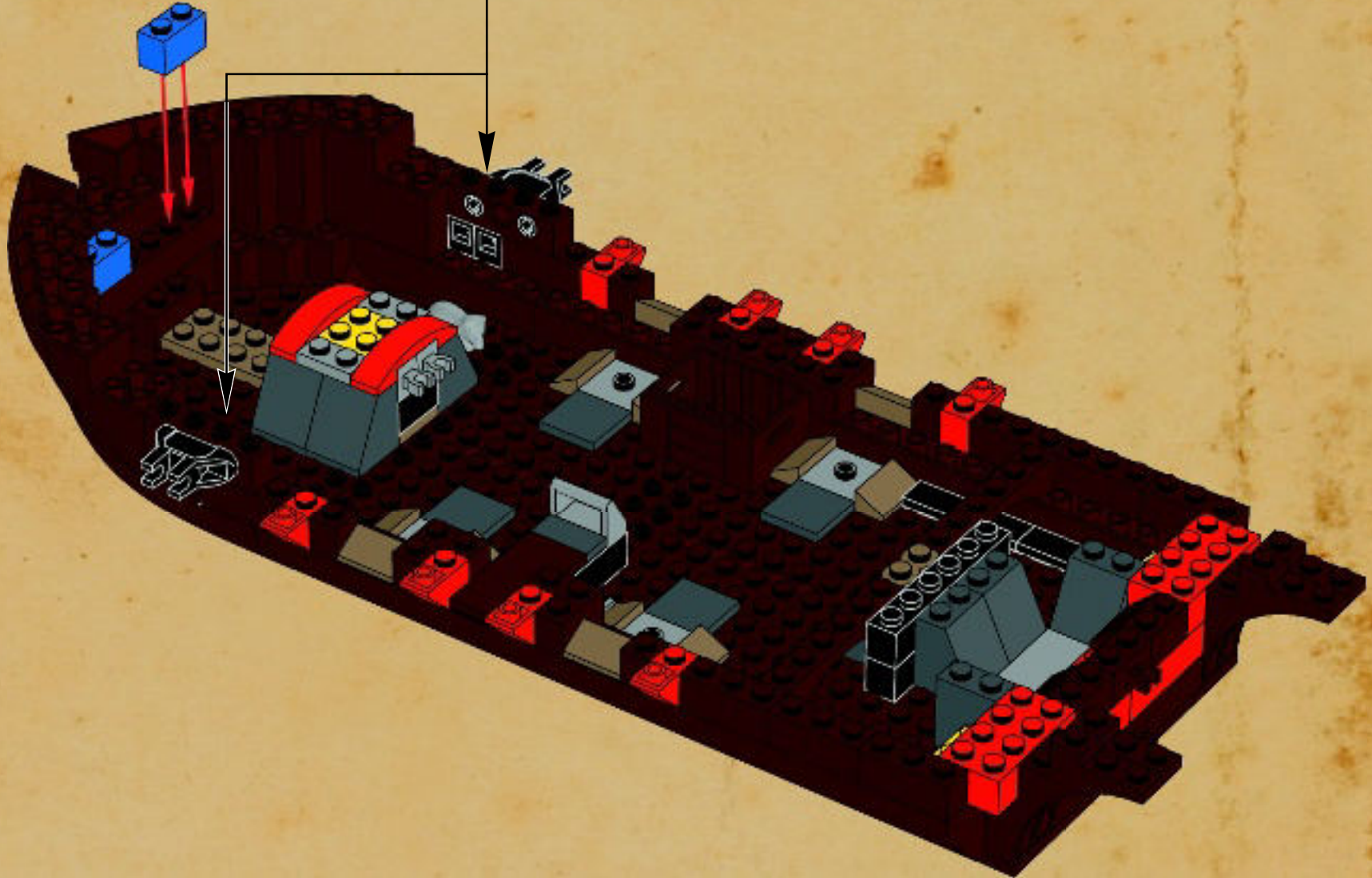
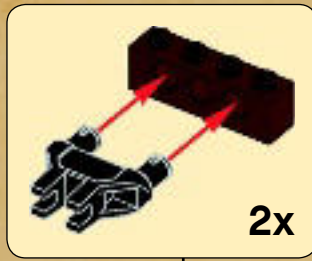



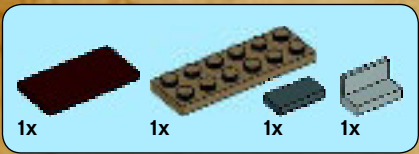

29

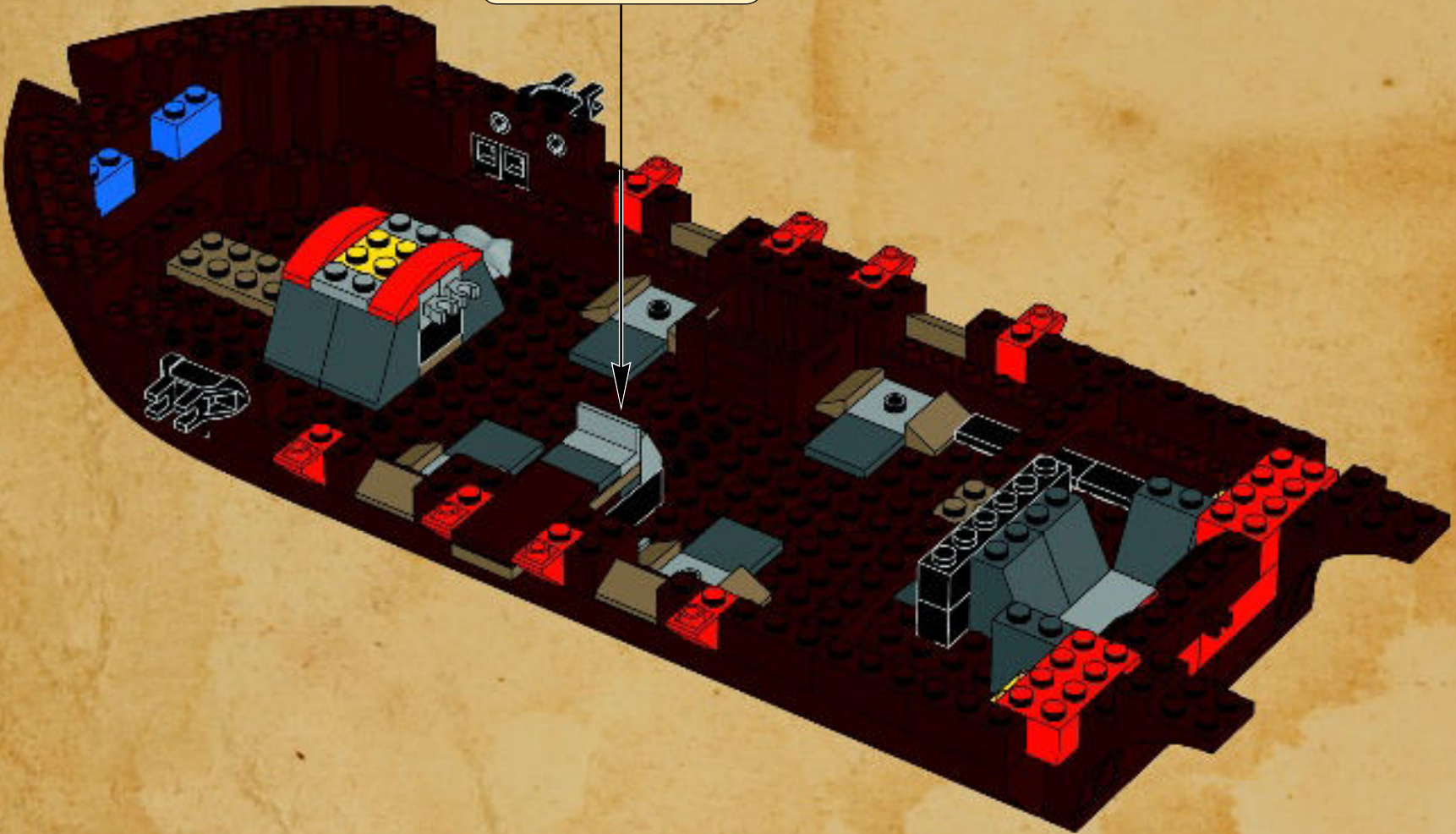
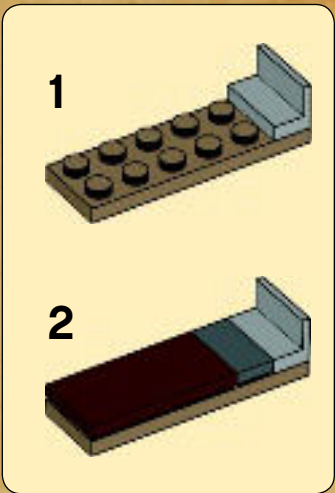



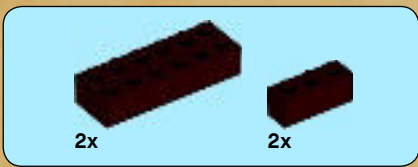

30

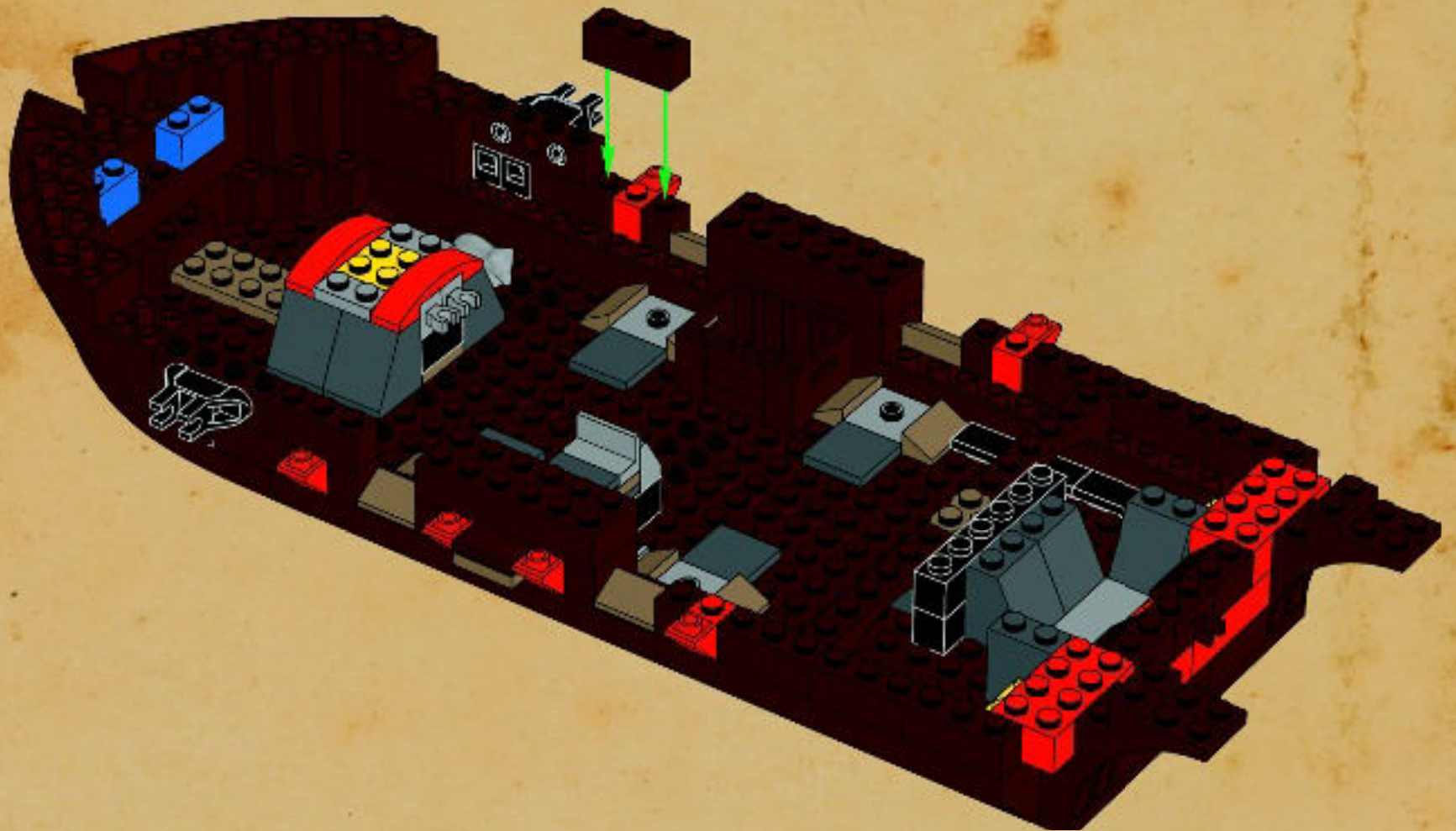





31

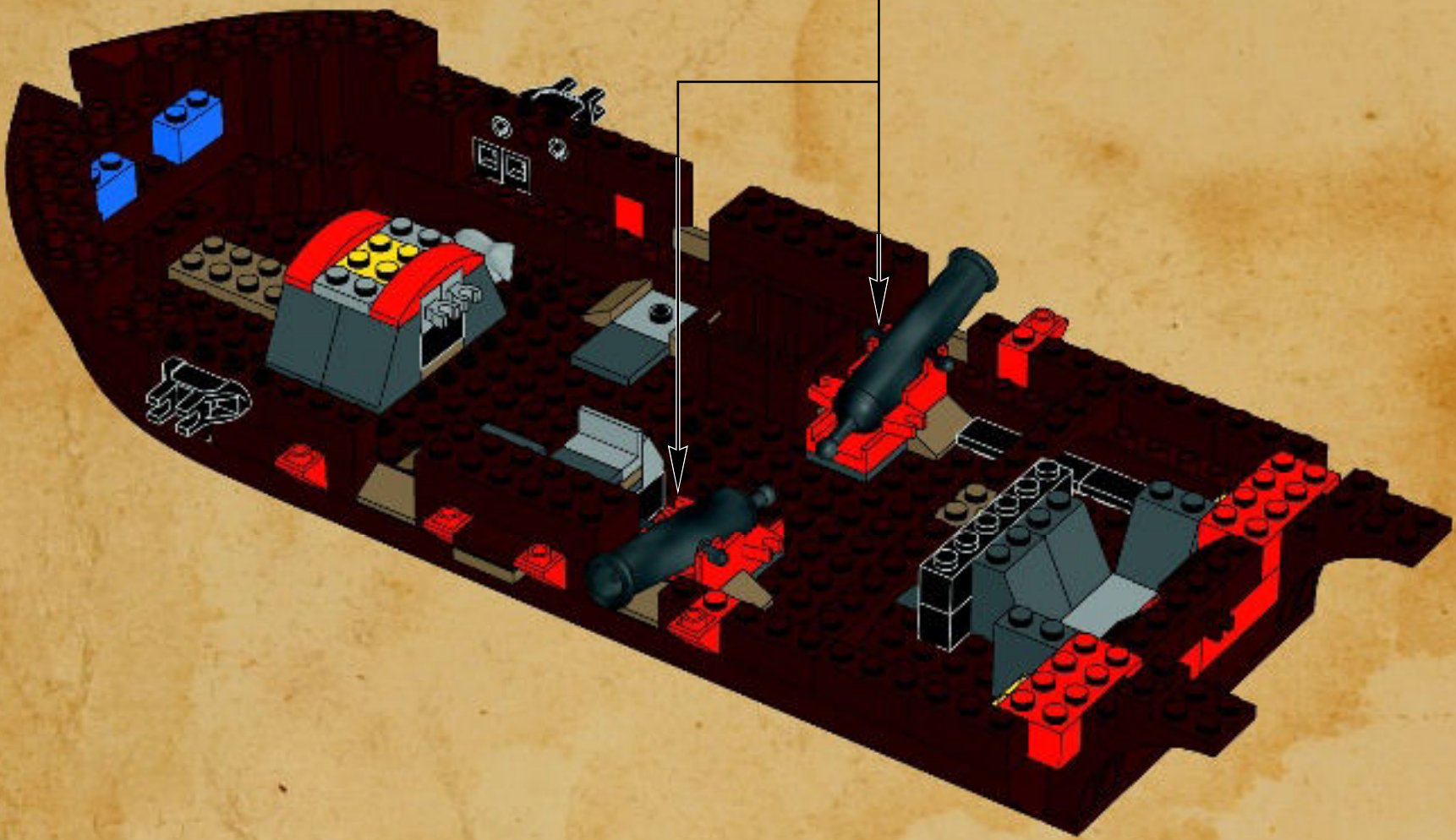
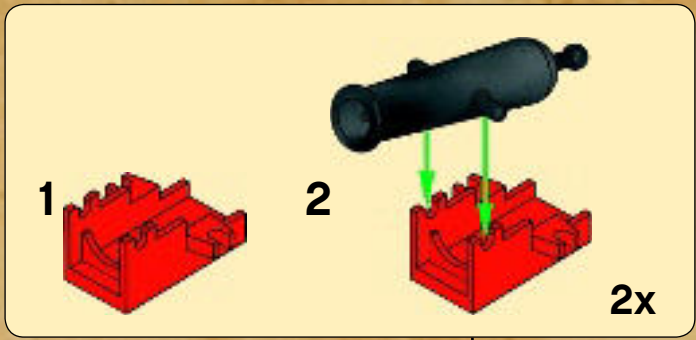





32

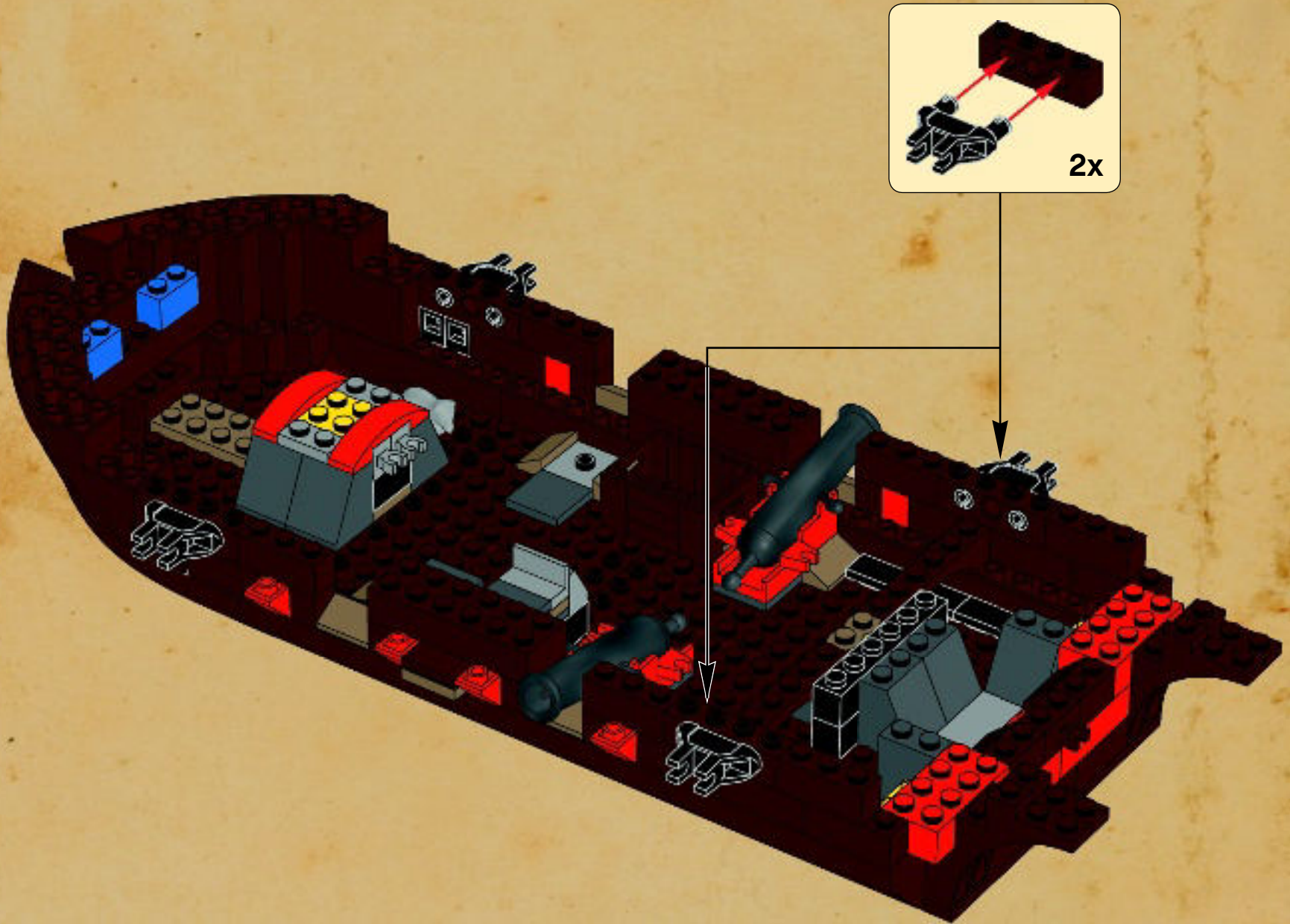





2x



1x

33

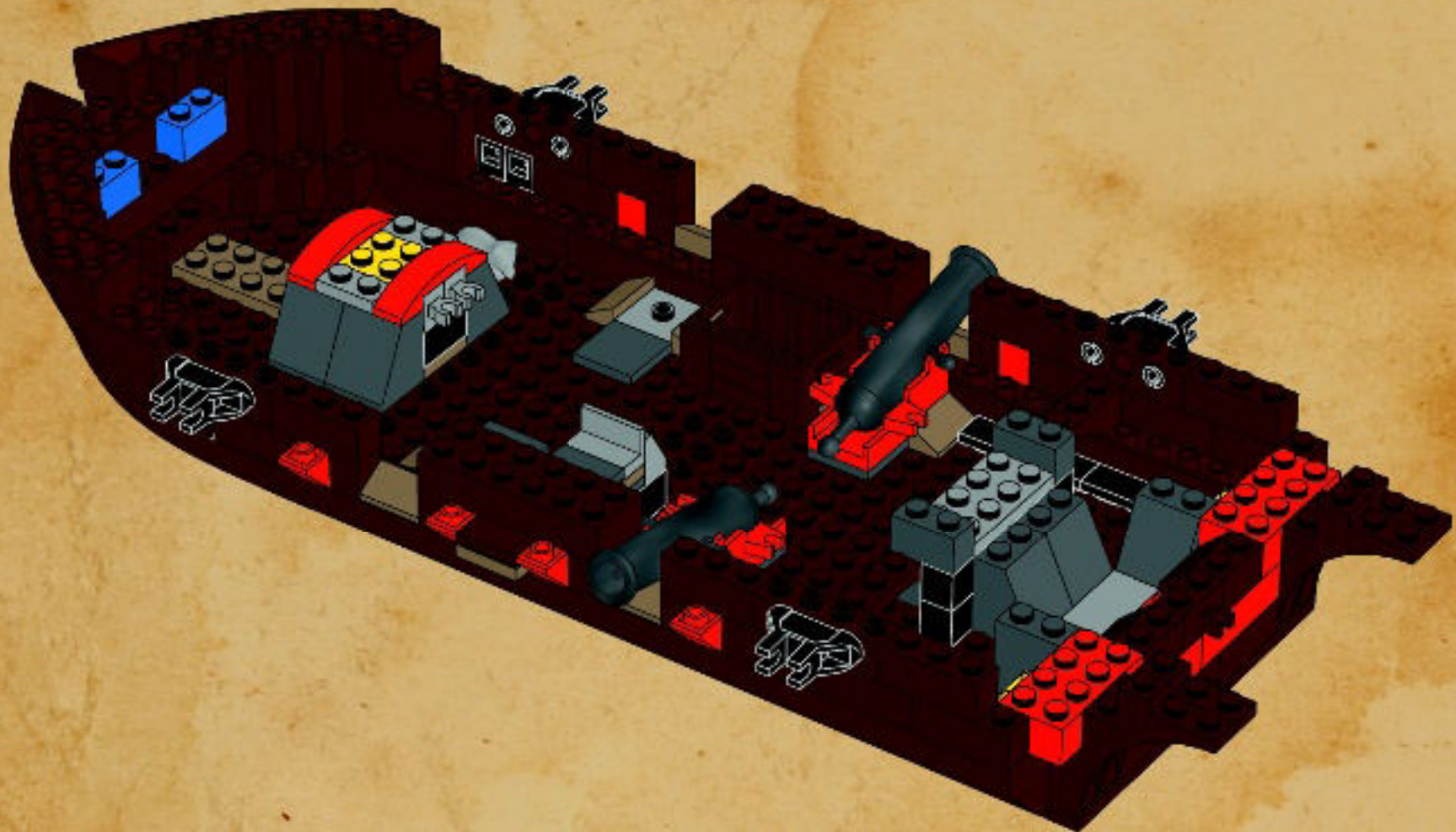





34

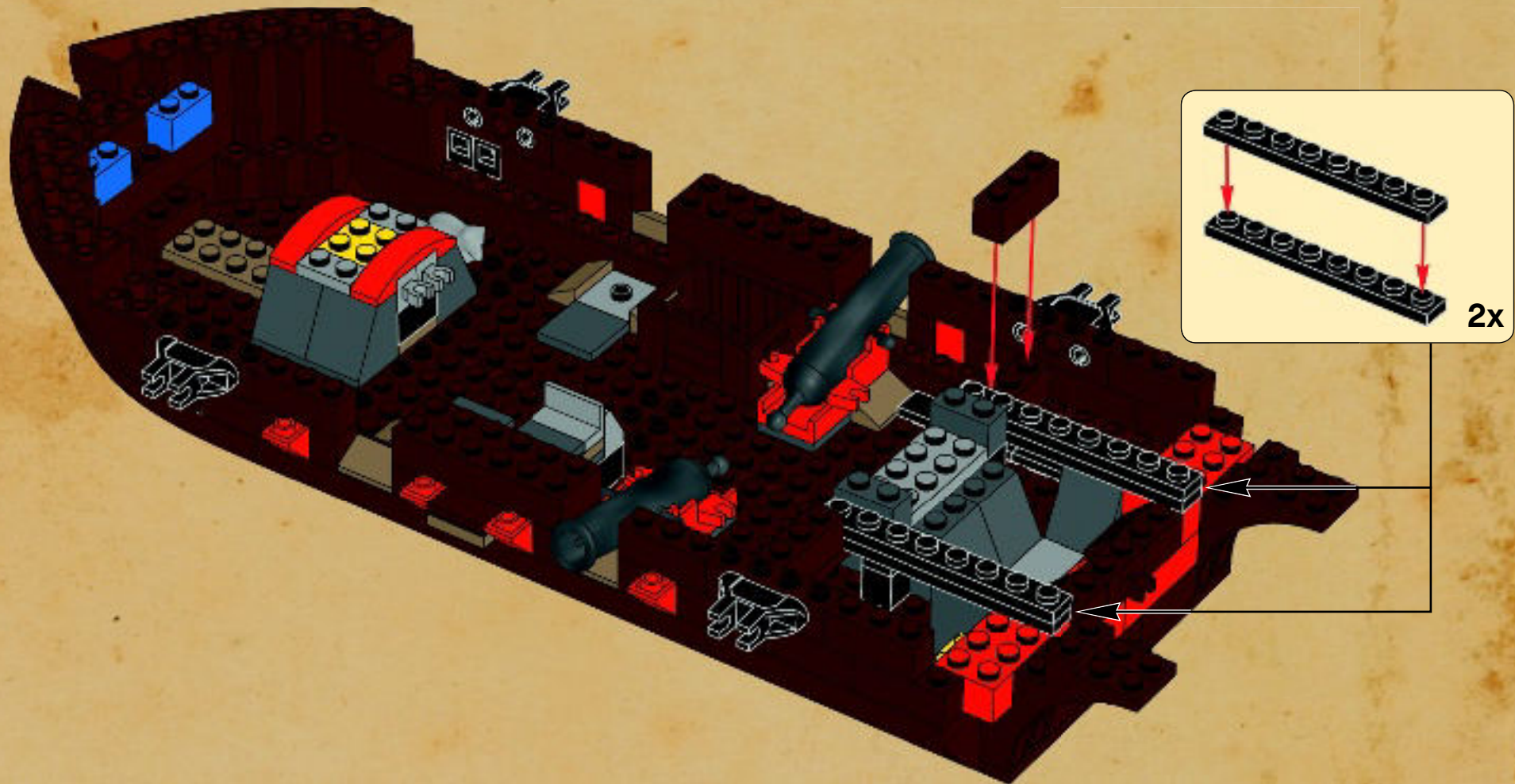



2x  4x  2x 

# 35

 2x

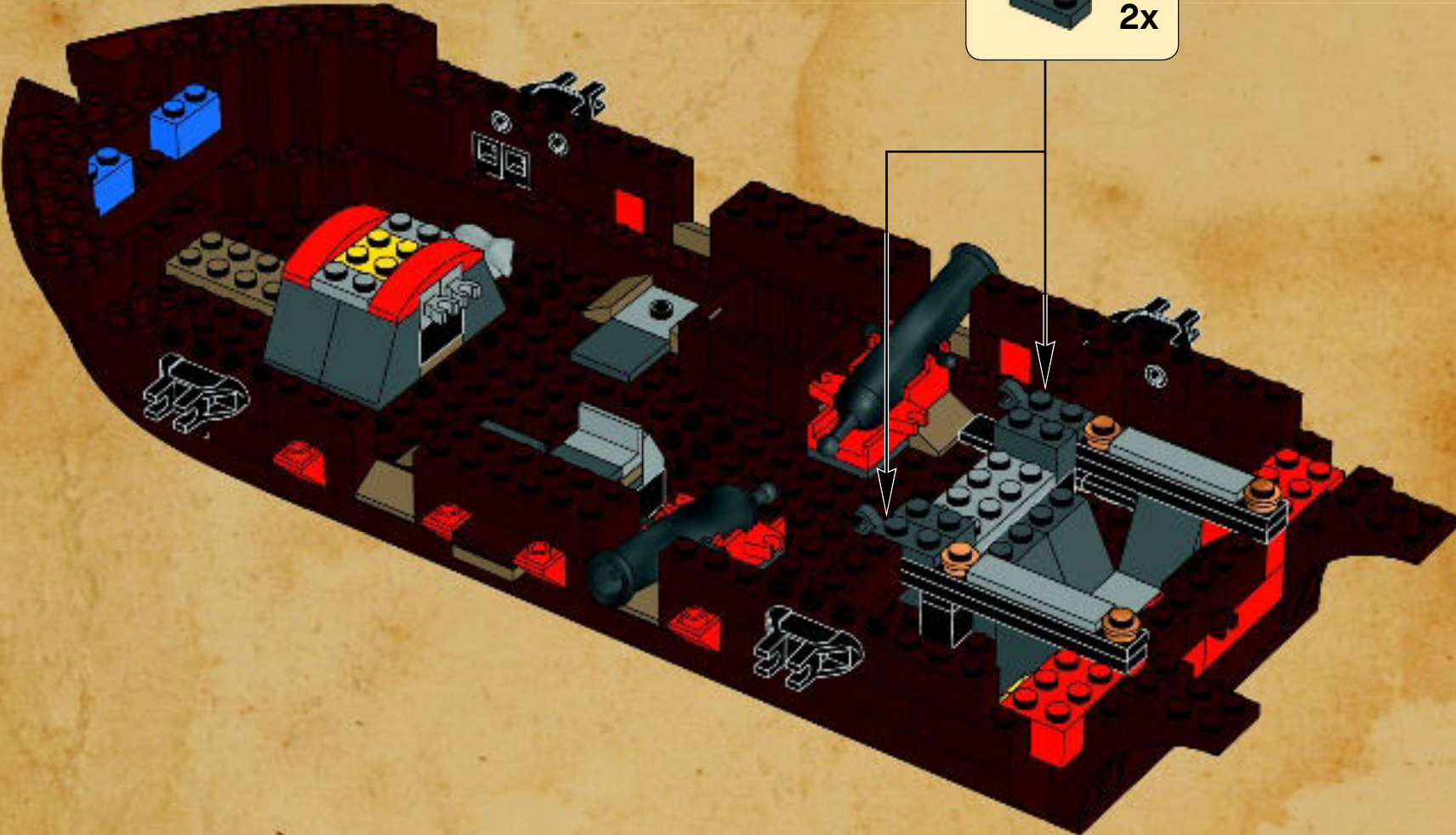



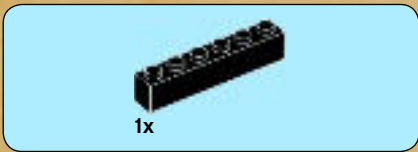

36

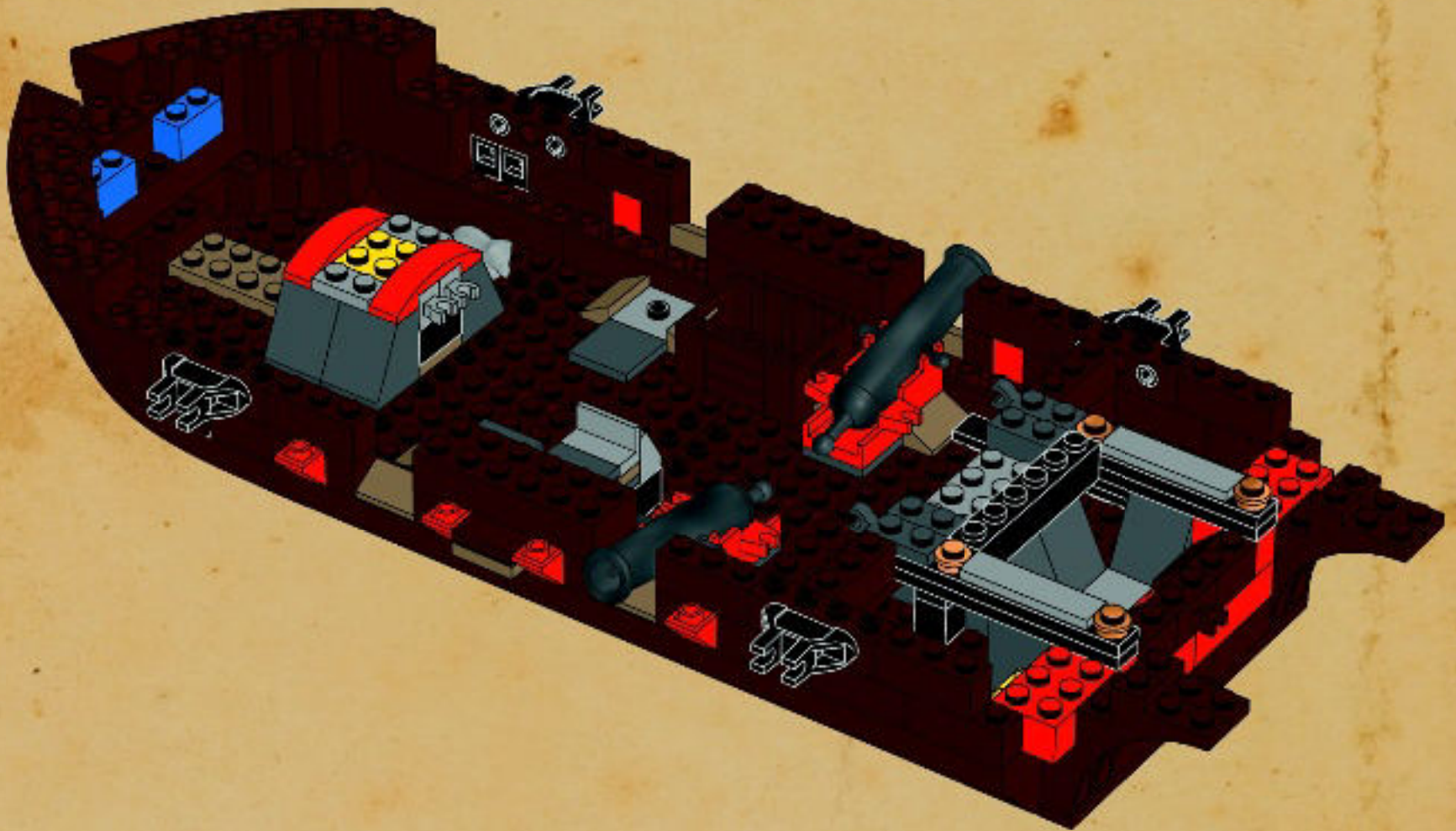





2x



2x

# 37

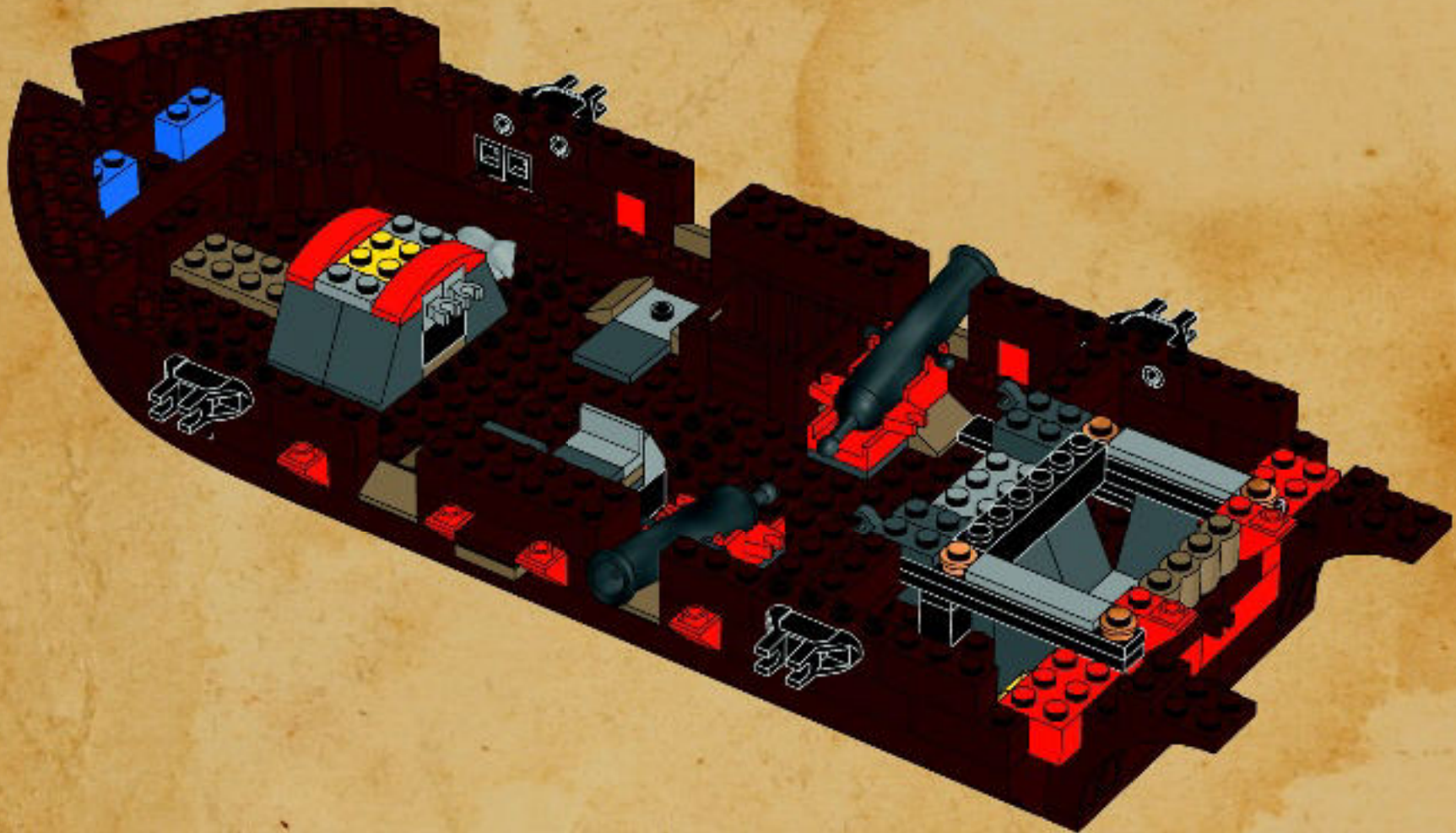





38

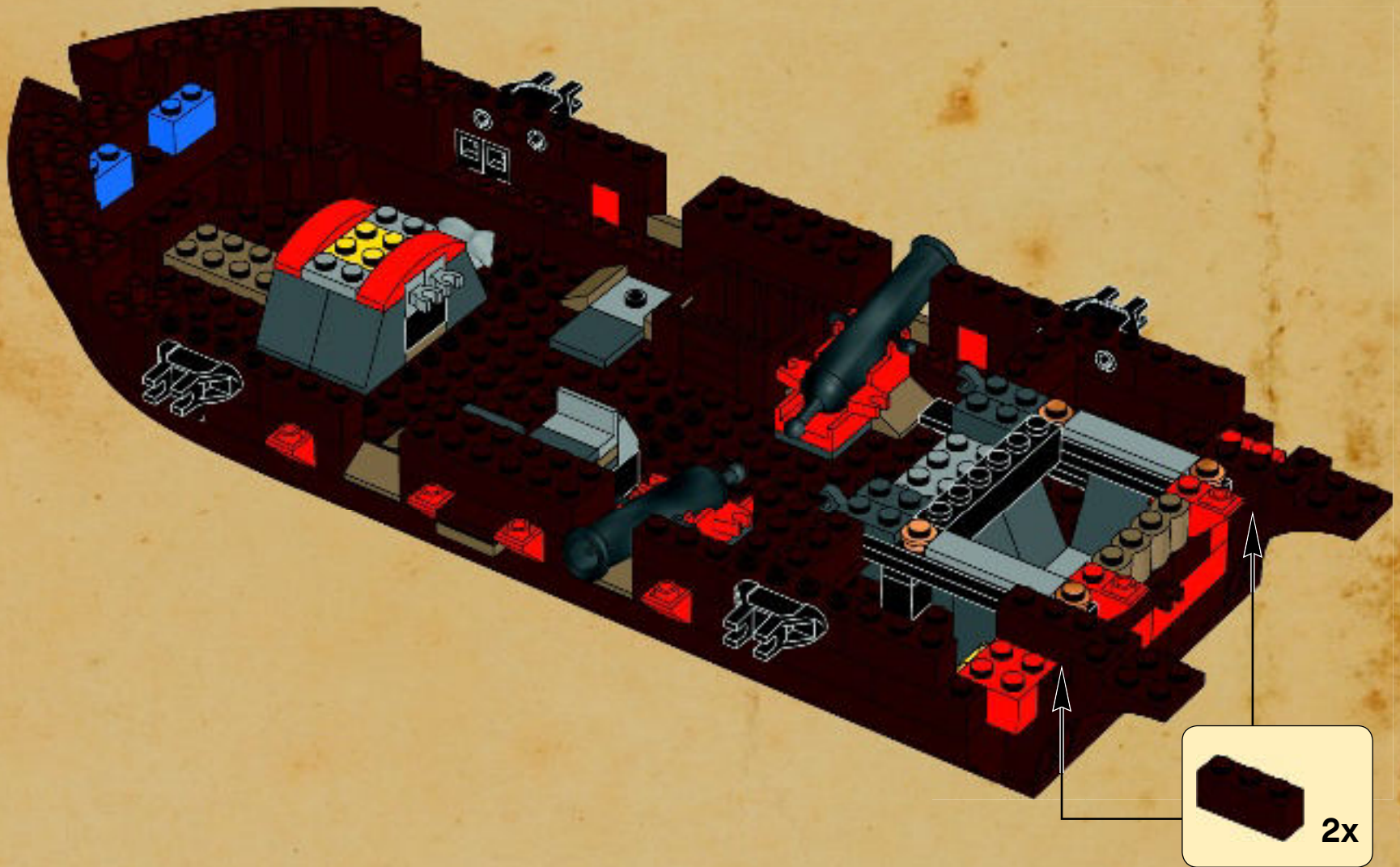





2x

39

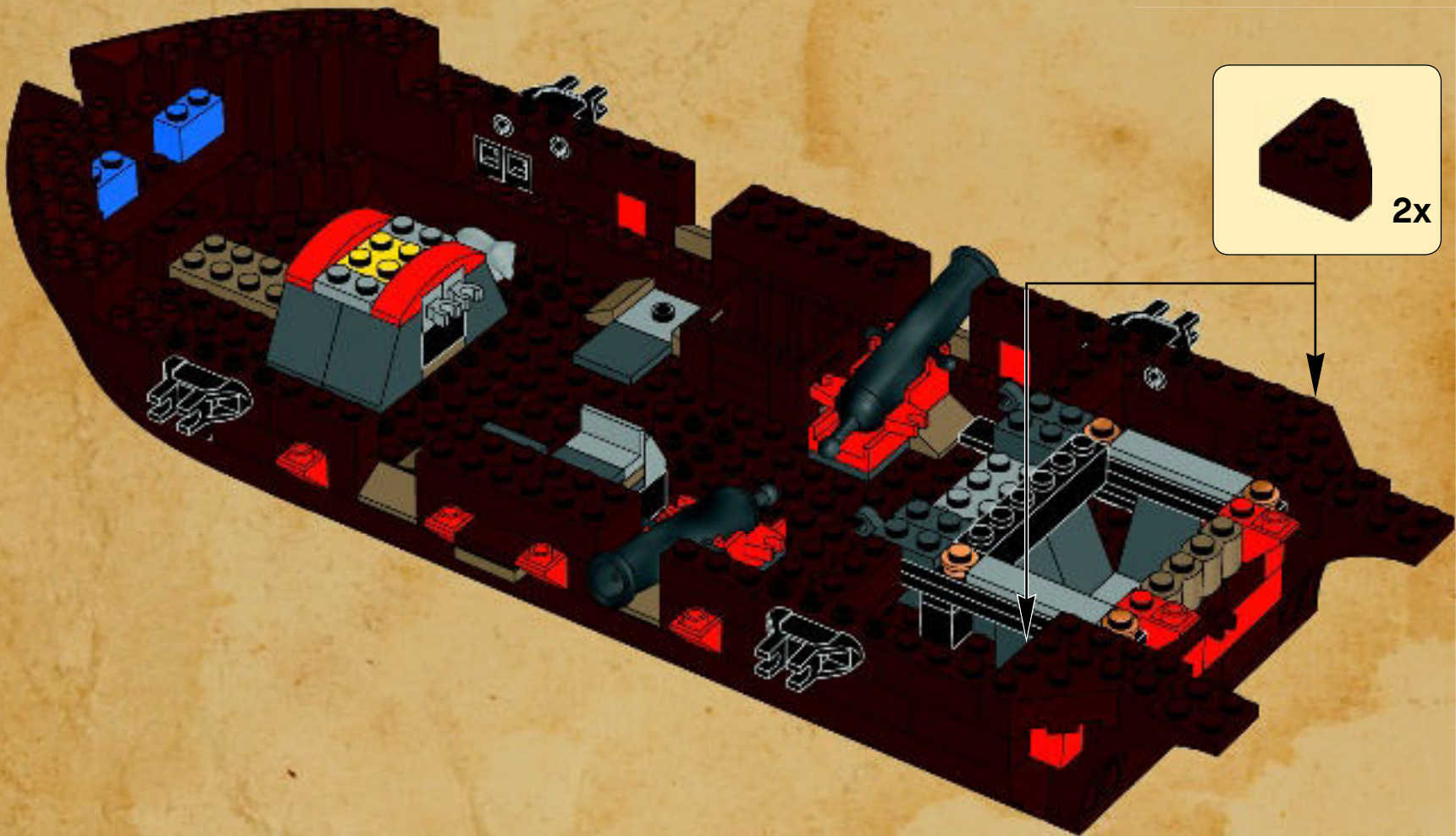





40

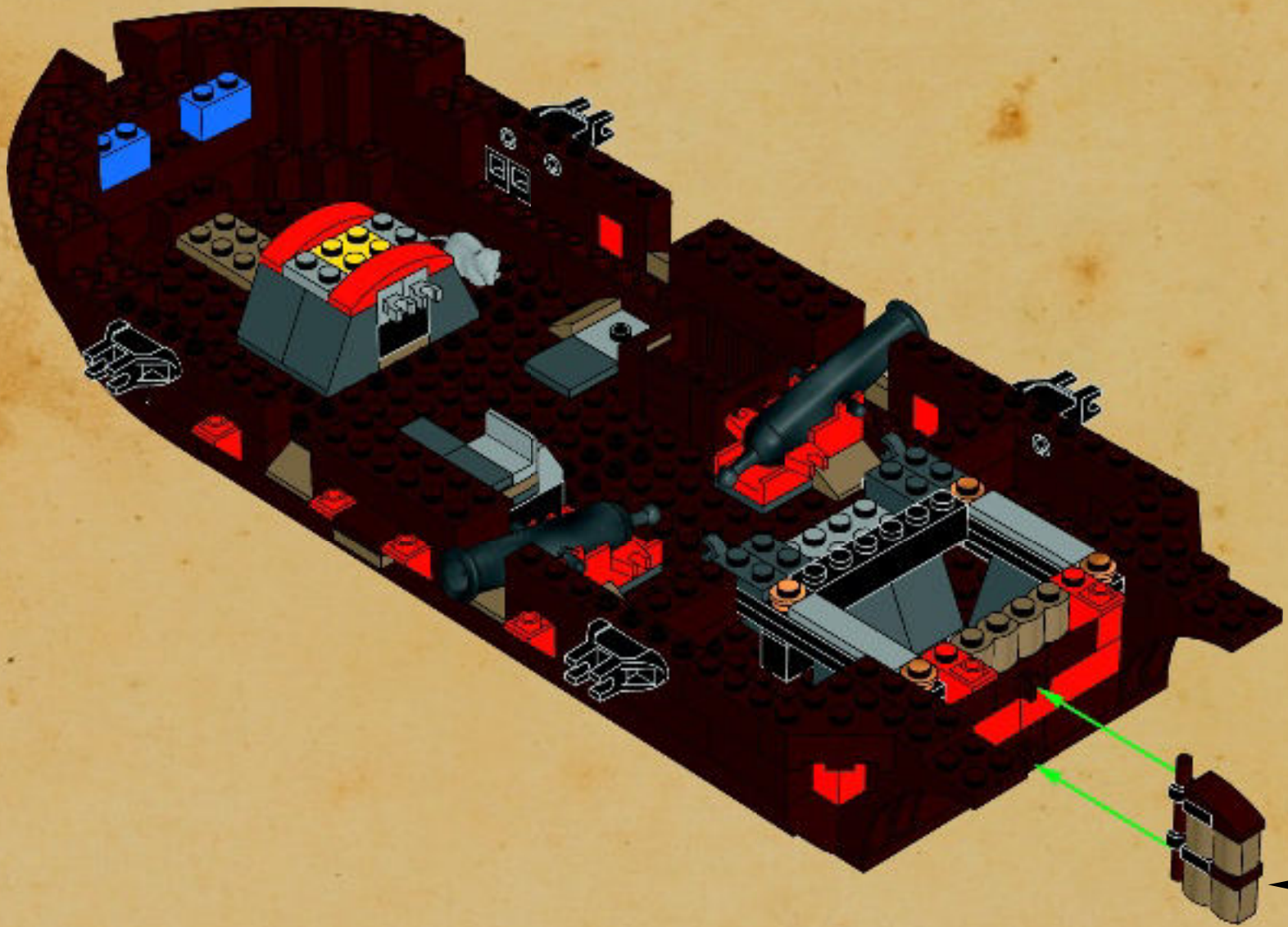
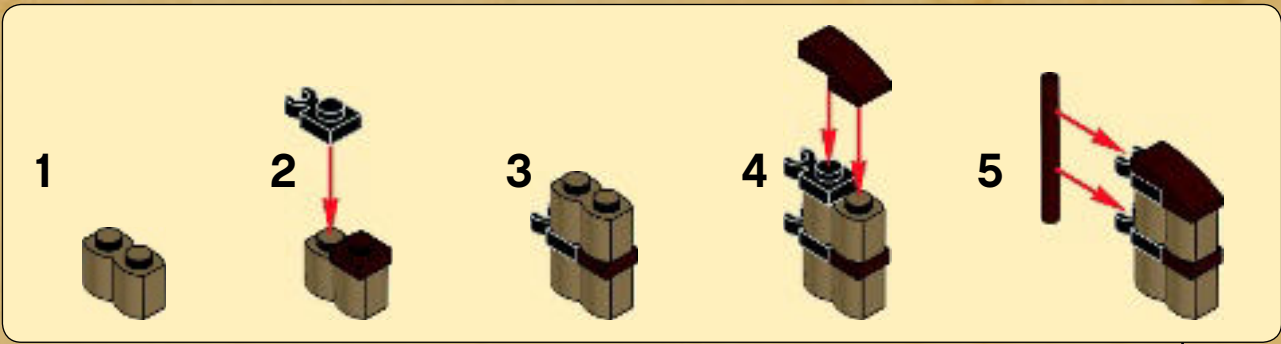





41

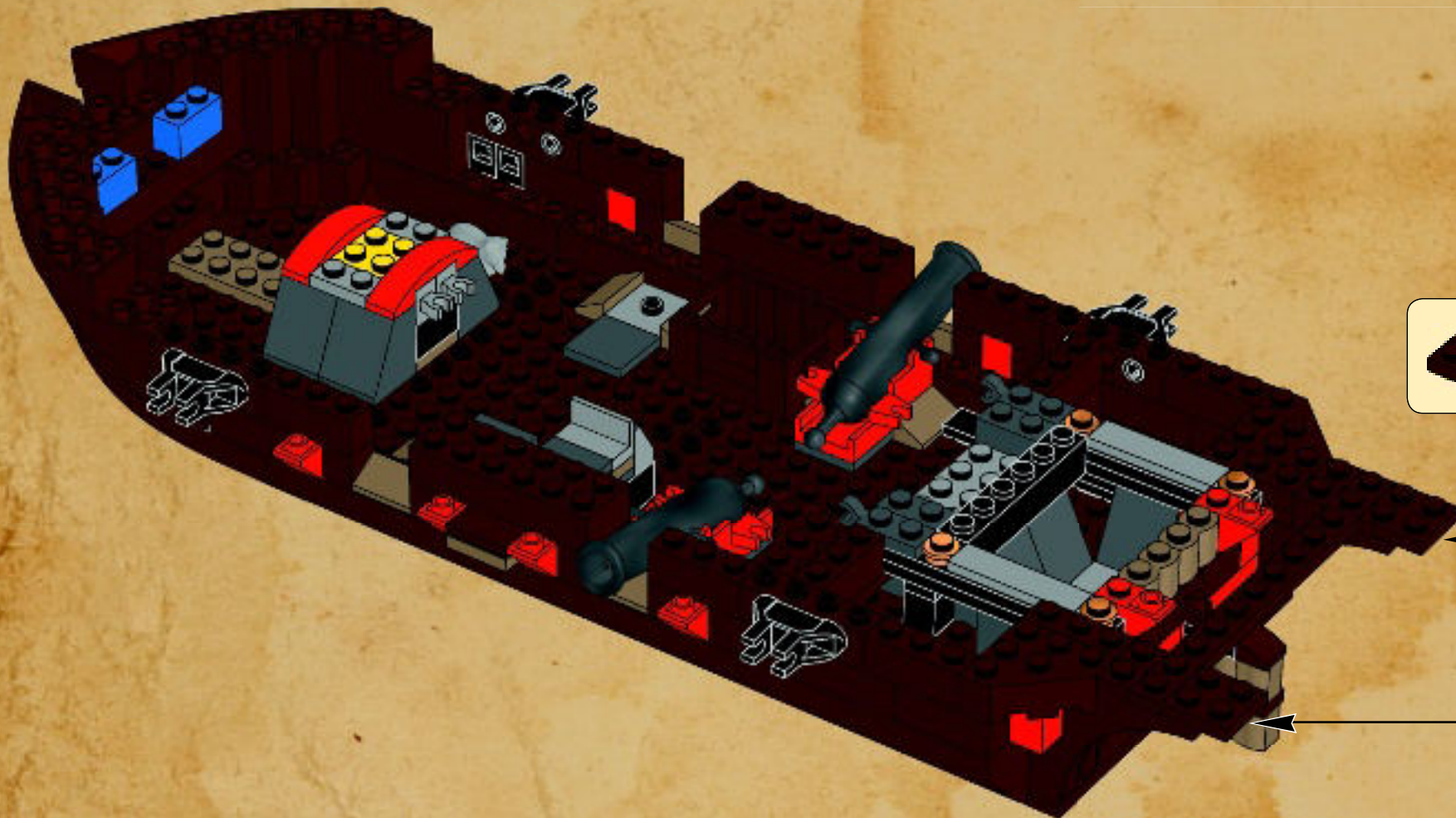



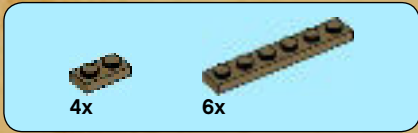
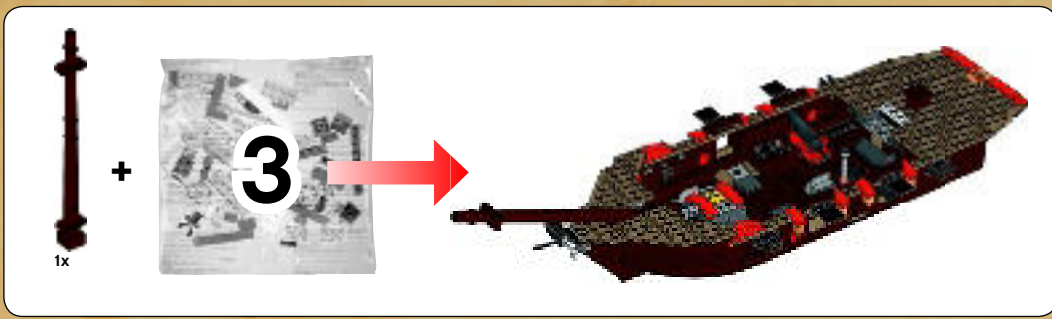

42

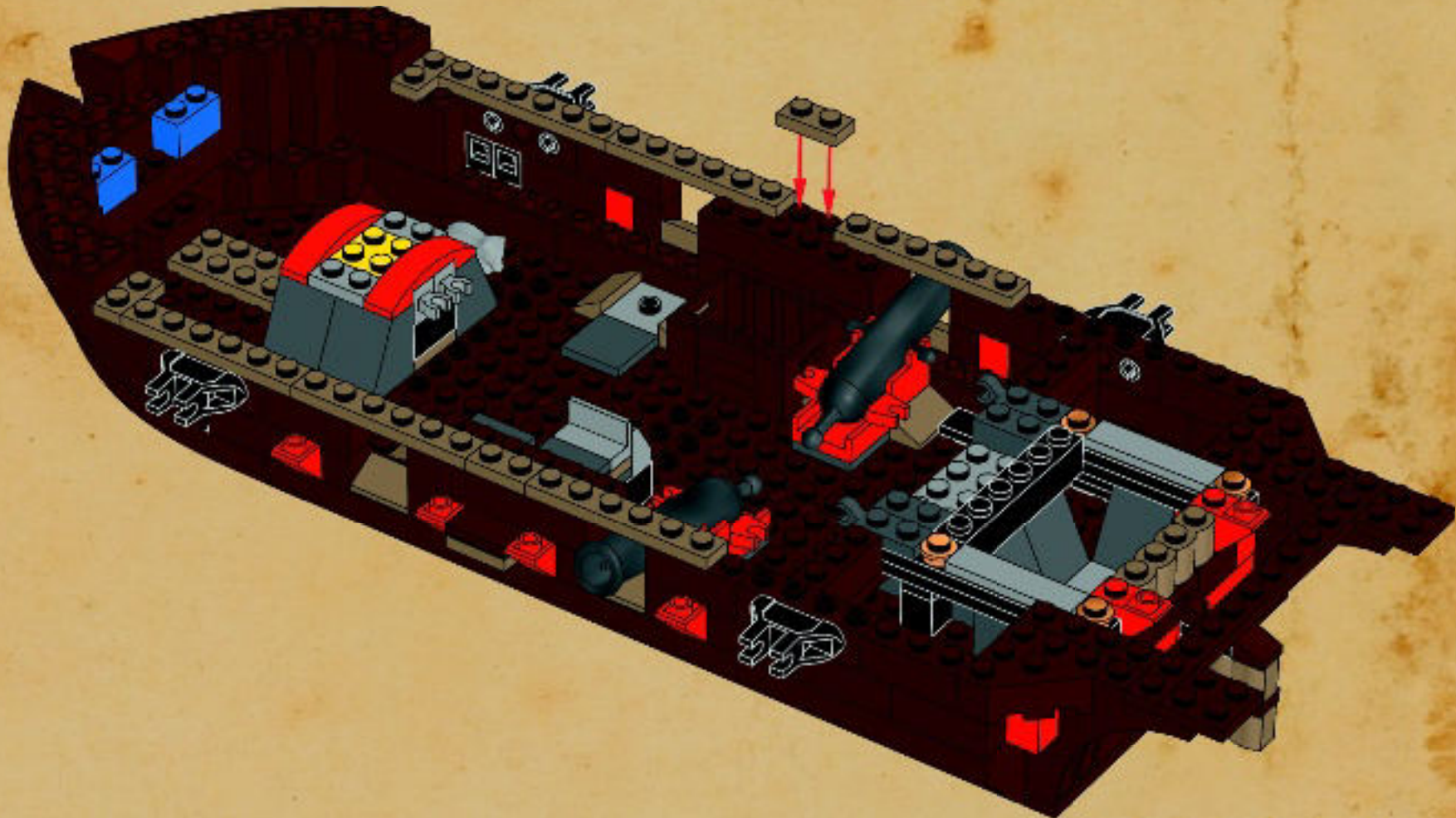





# 43

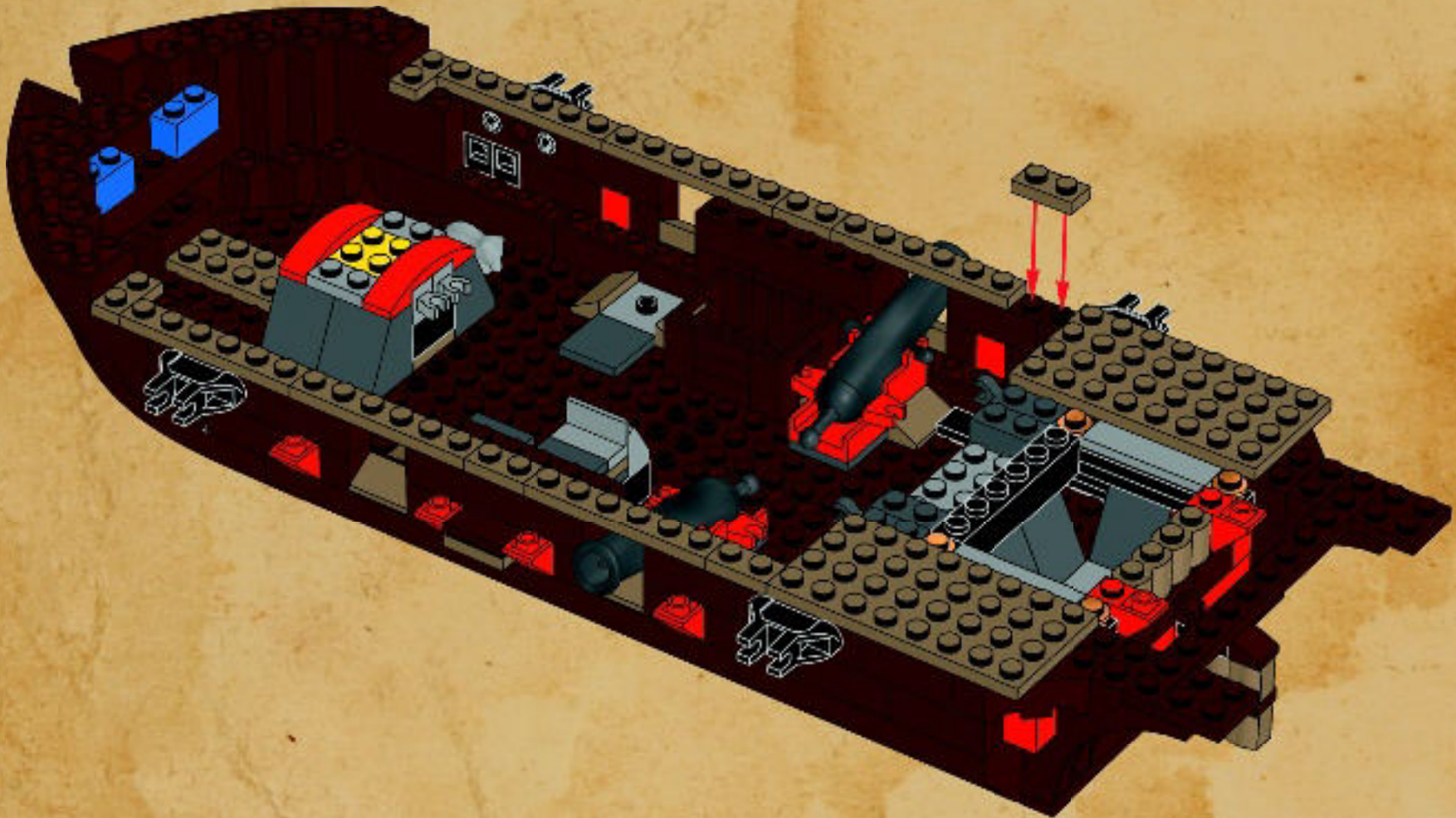





44

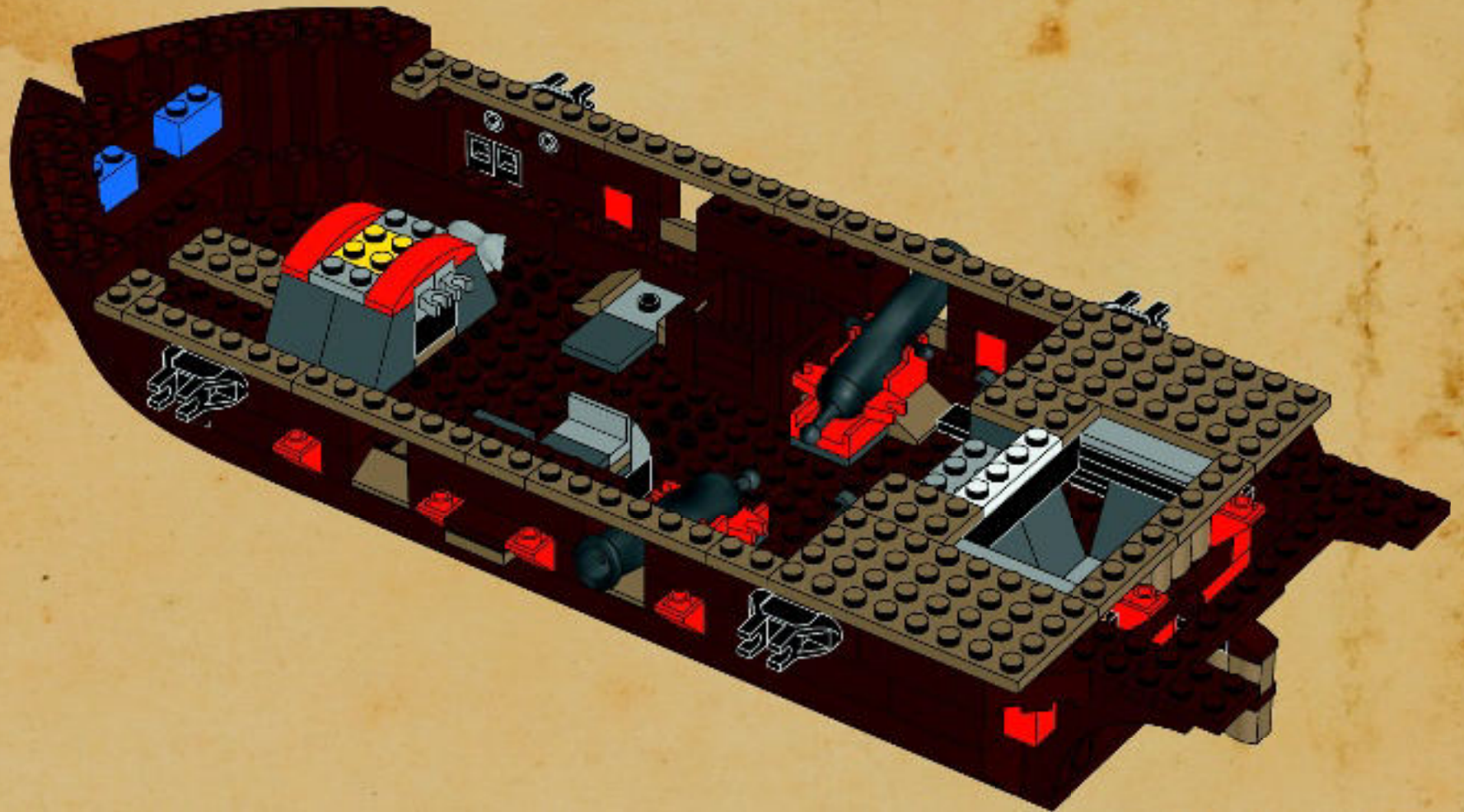



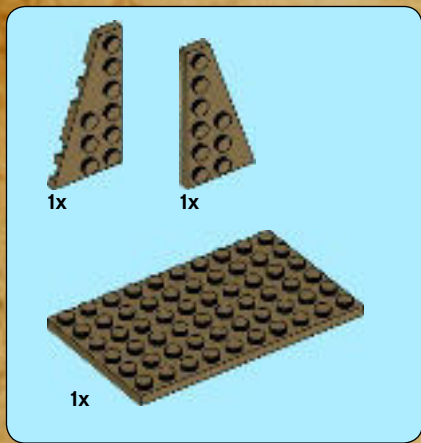

45

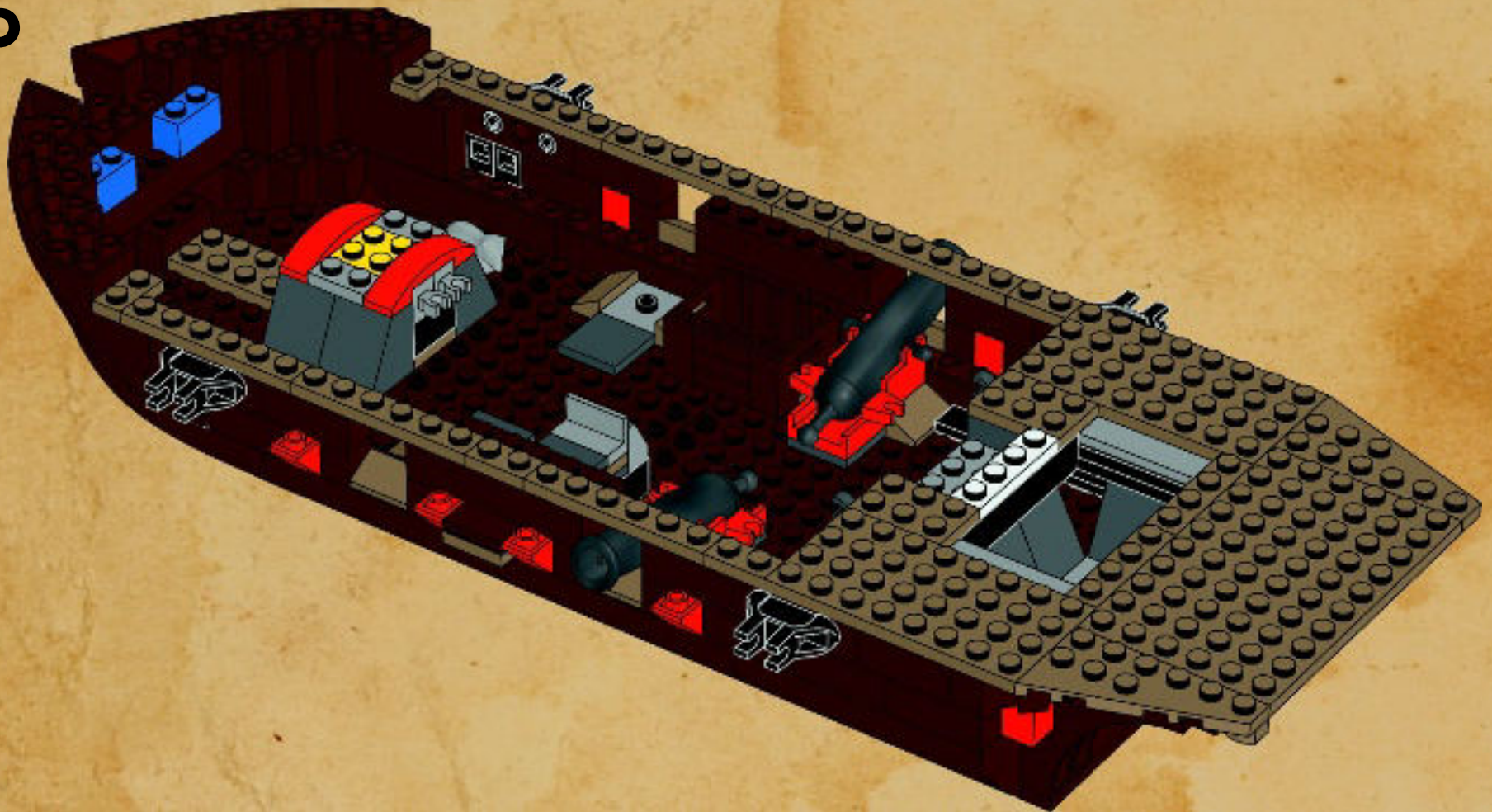





46

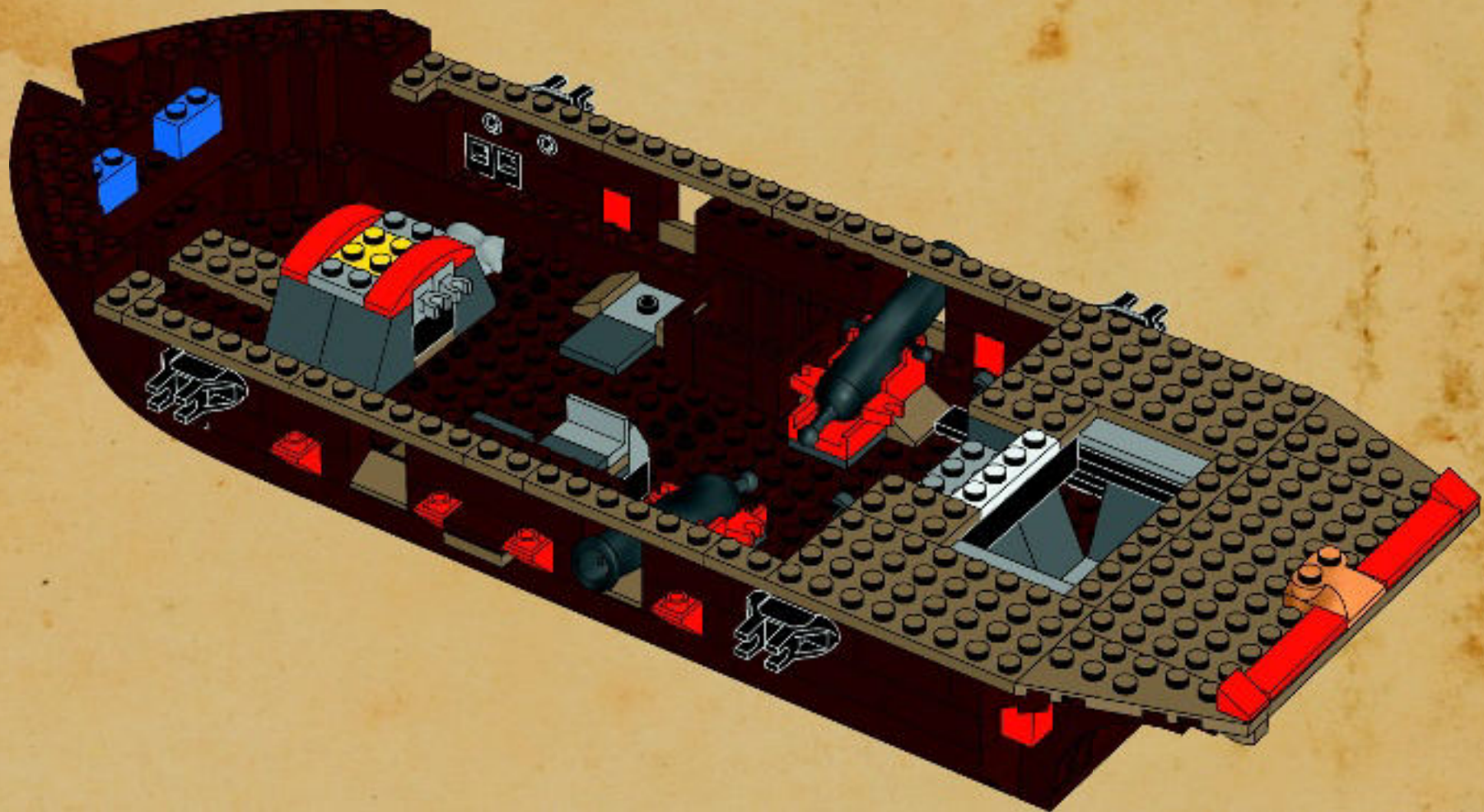





47

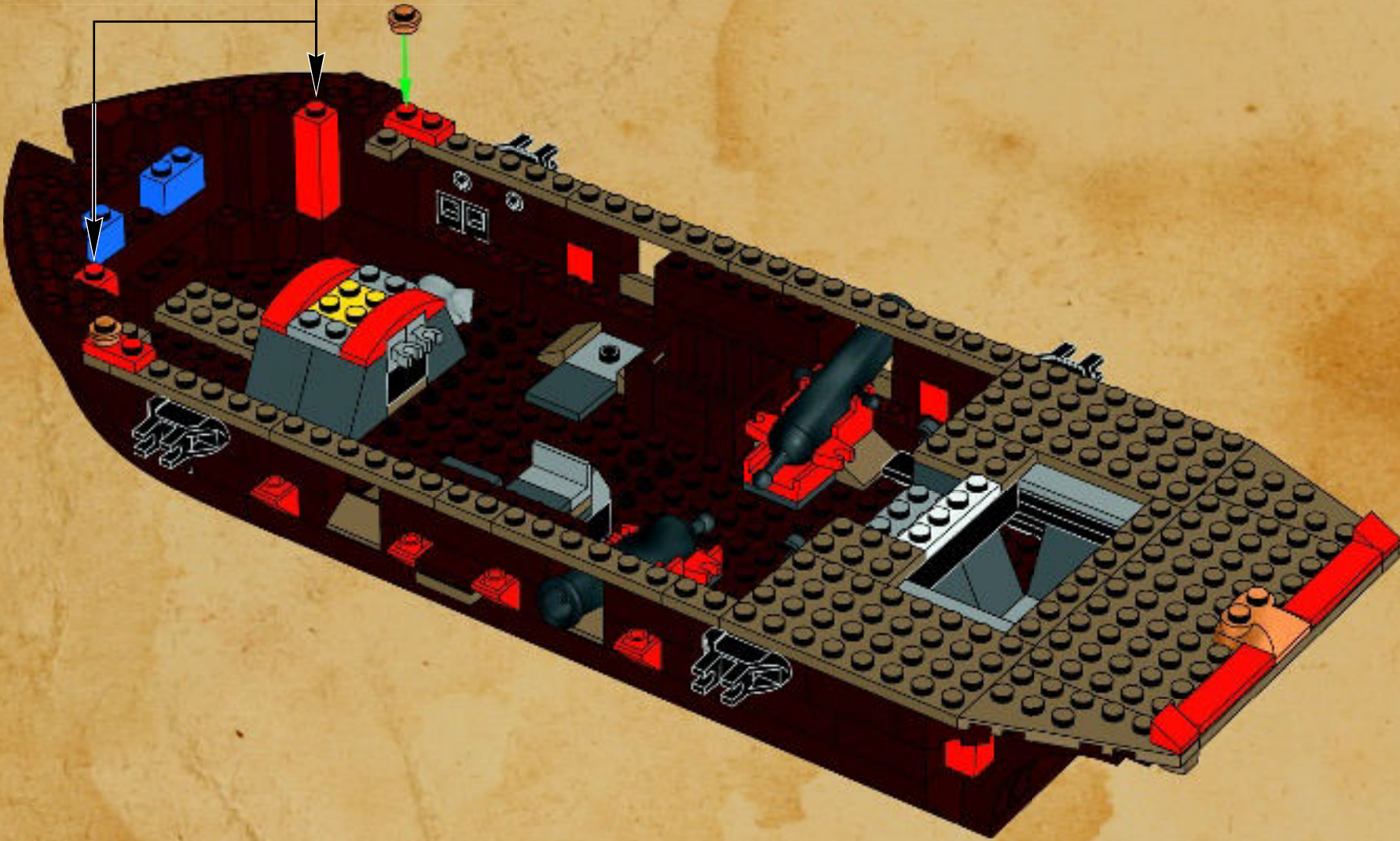





2x



8x

# 48

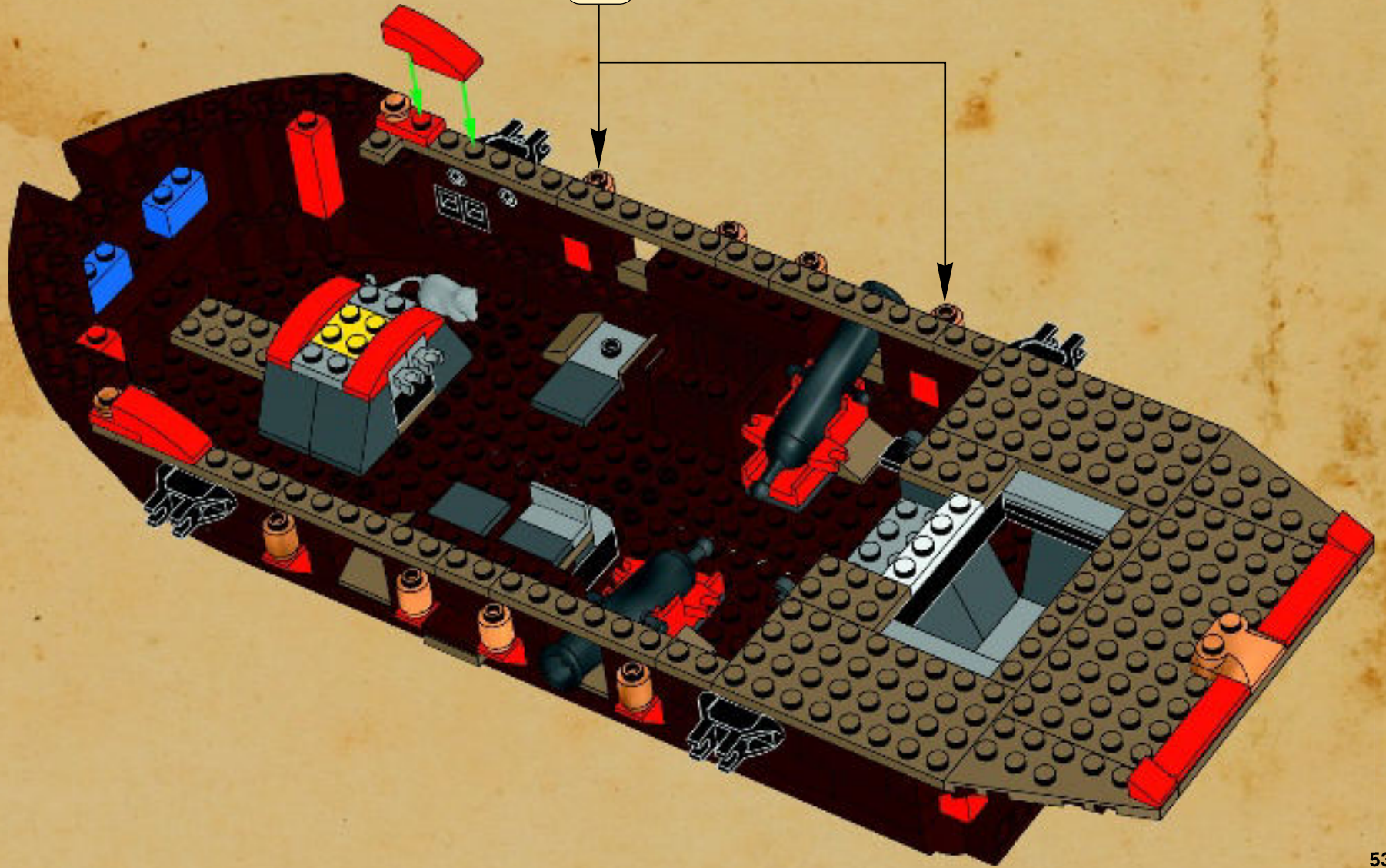





2x



4x



4x

# 49

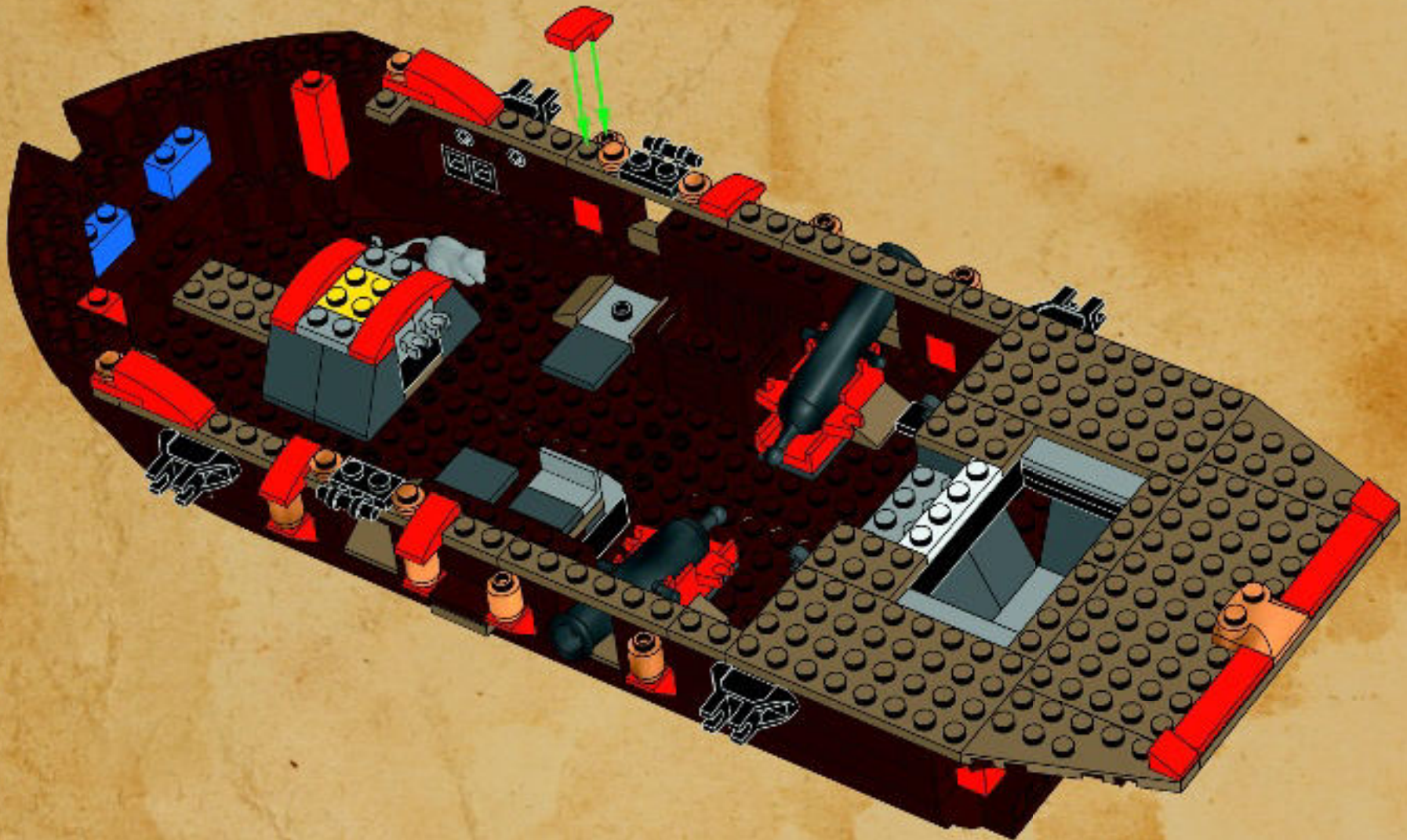



2x 4x 4x

50

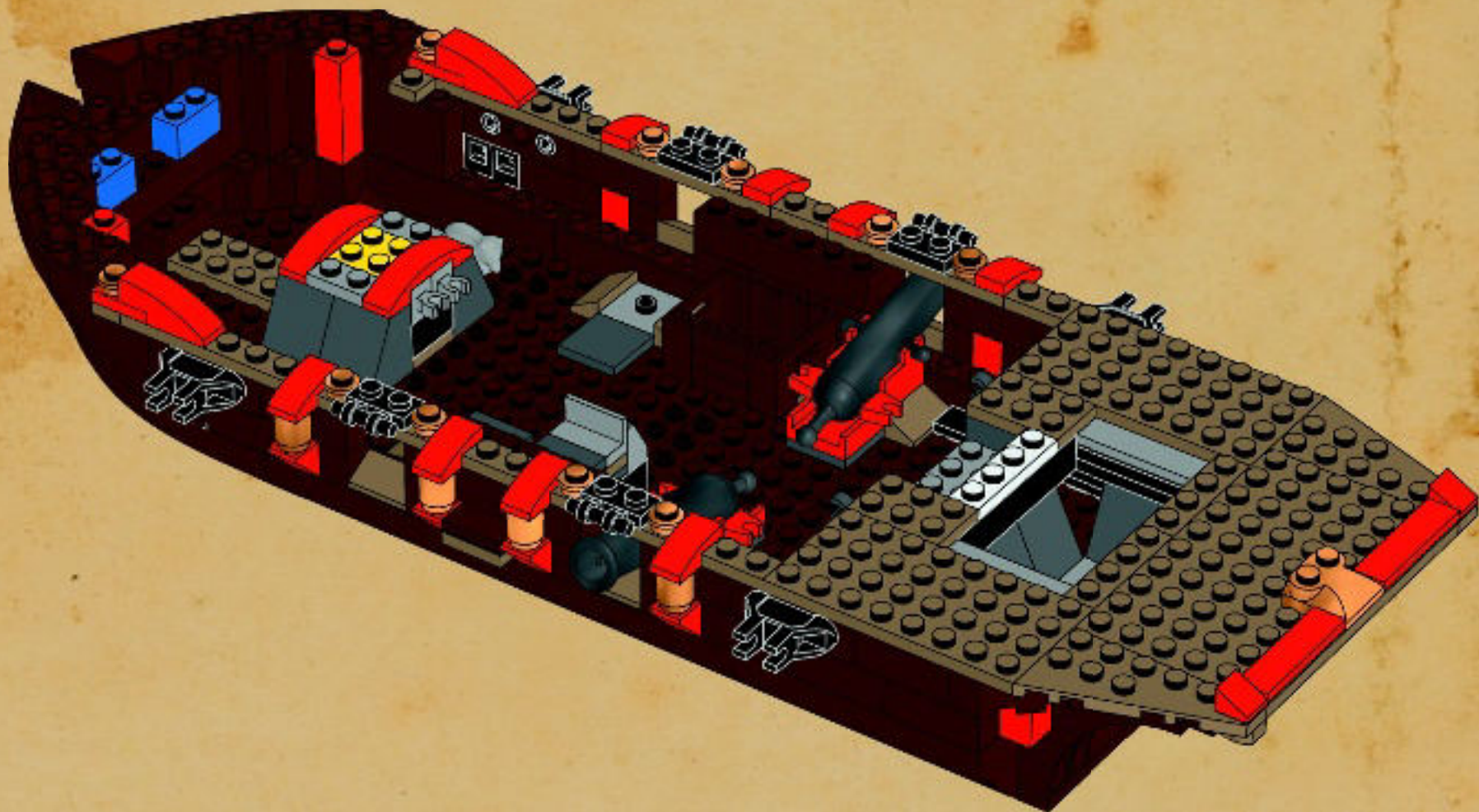



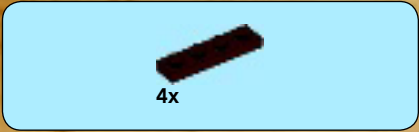

51

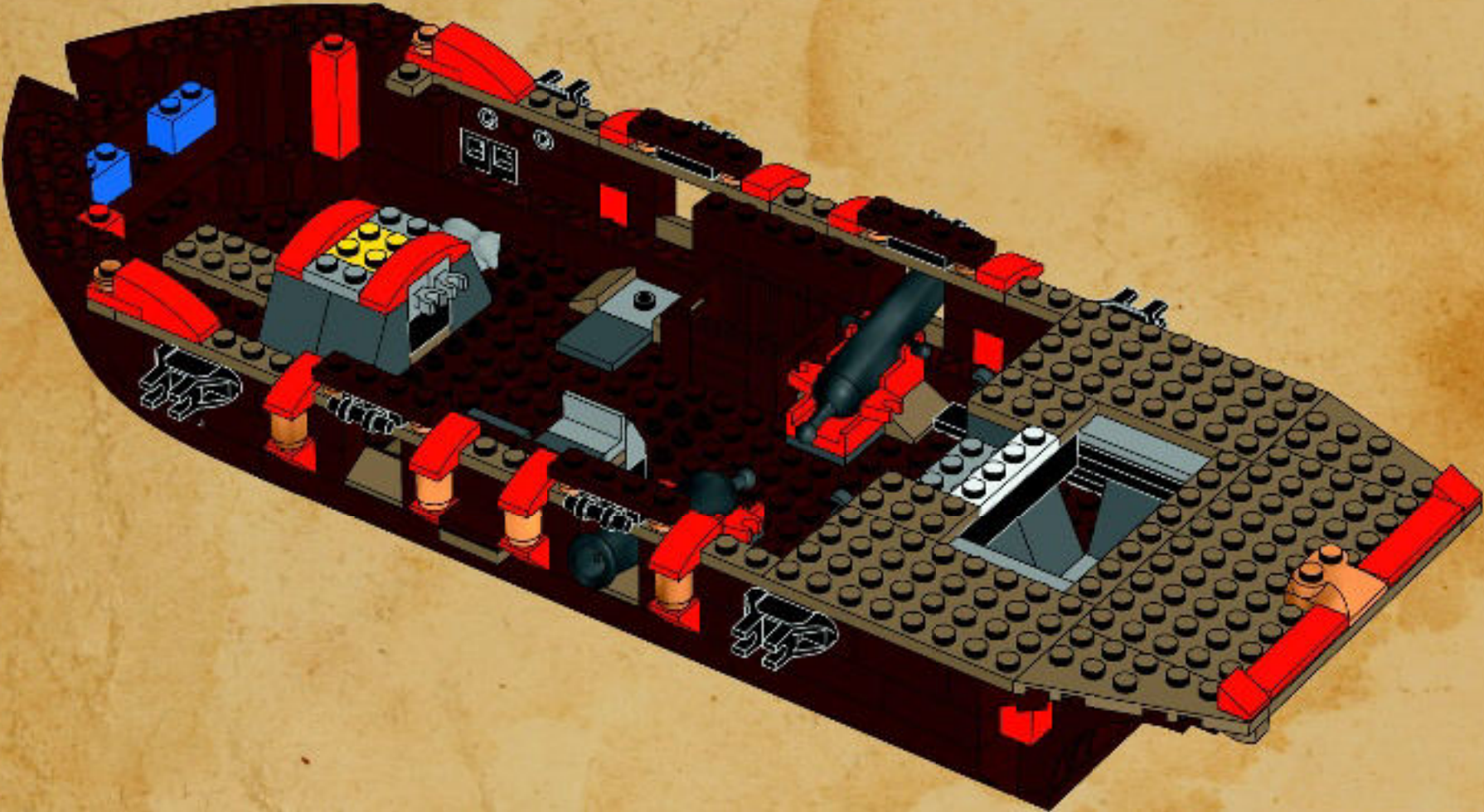



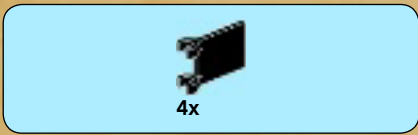

52

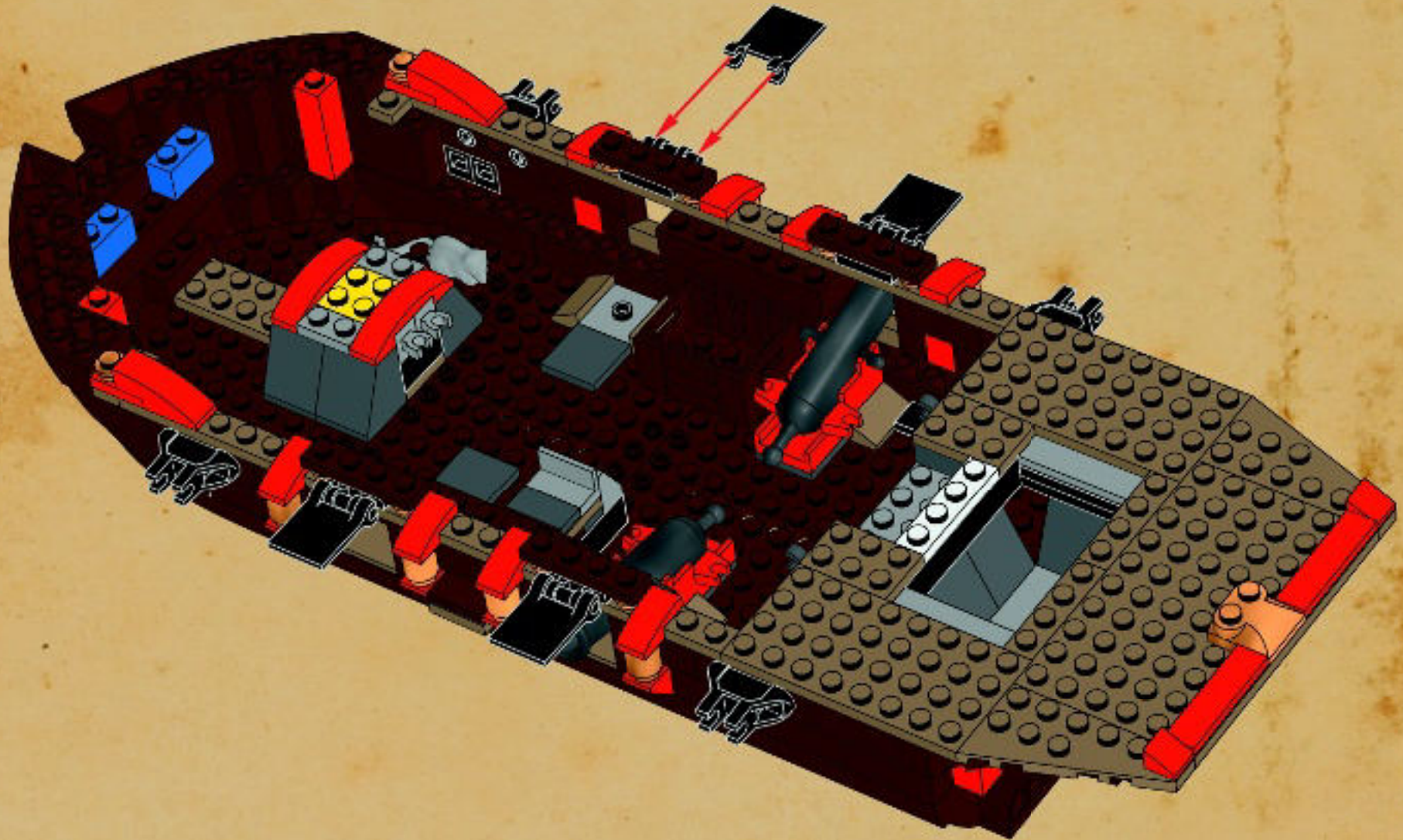



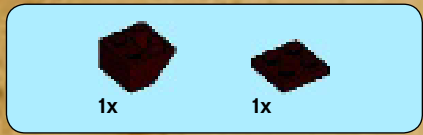

1



2



3



4







5

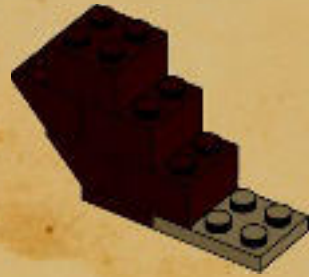

6

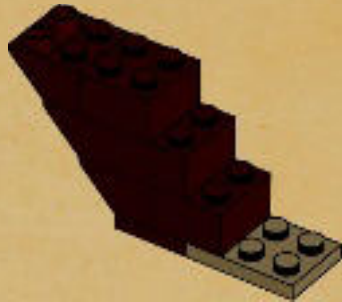

7

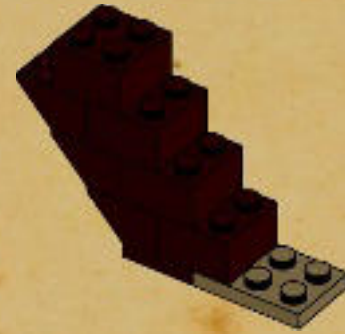

8

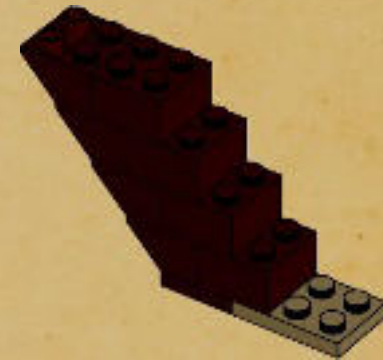



53

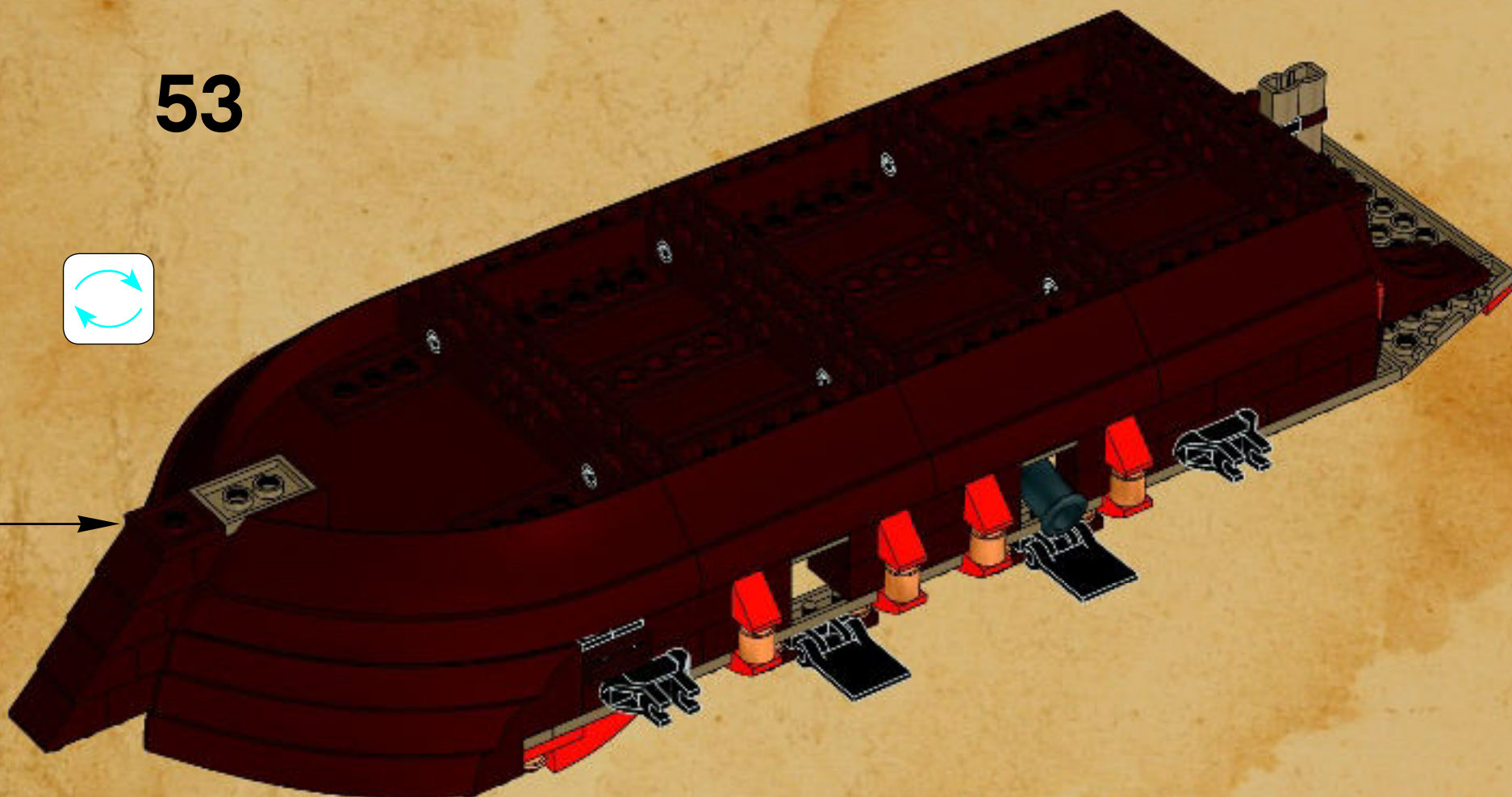



9x

# 54

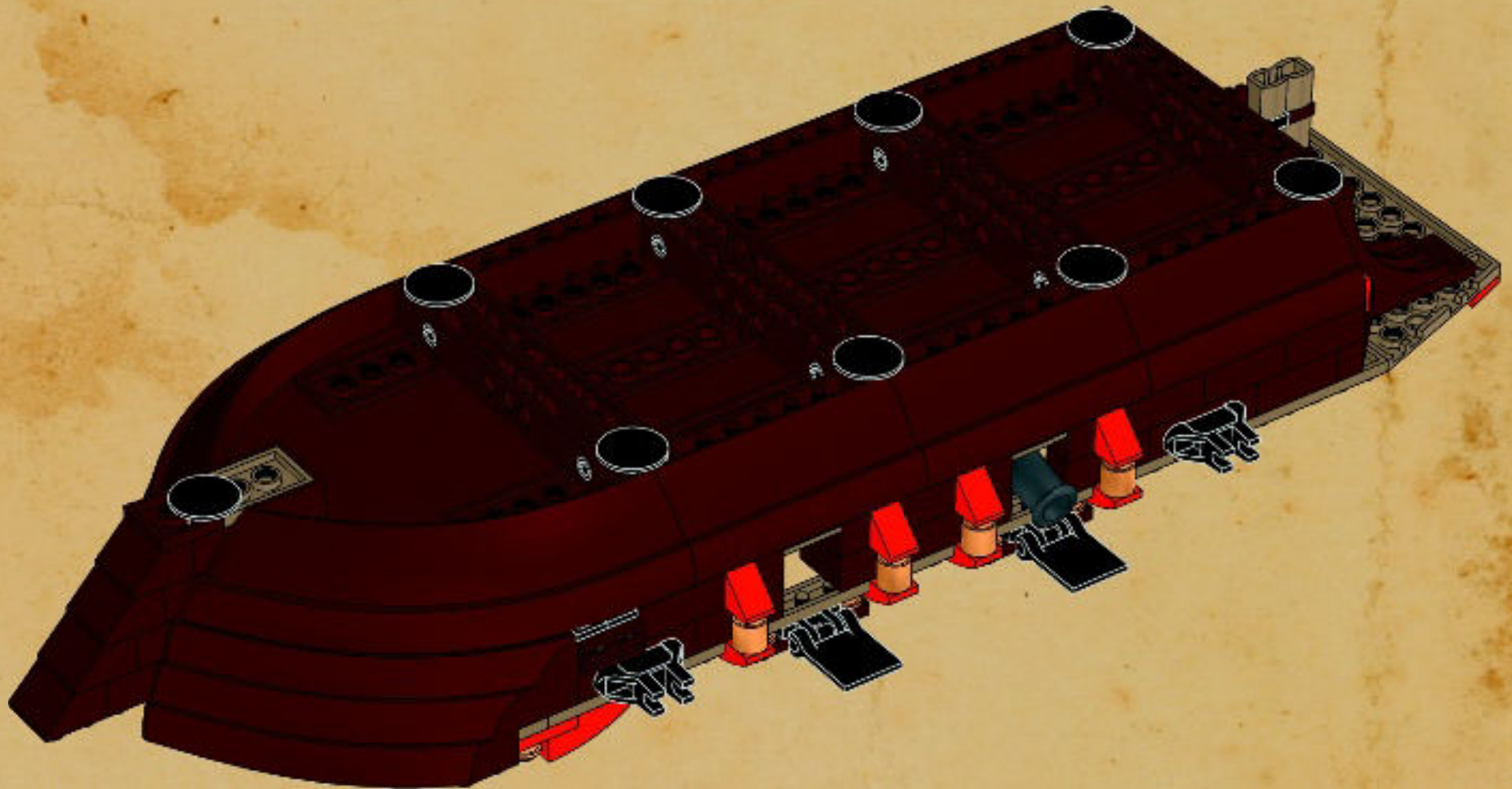



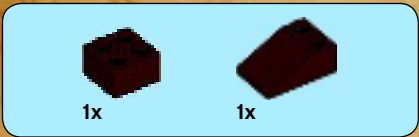

# 55

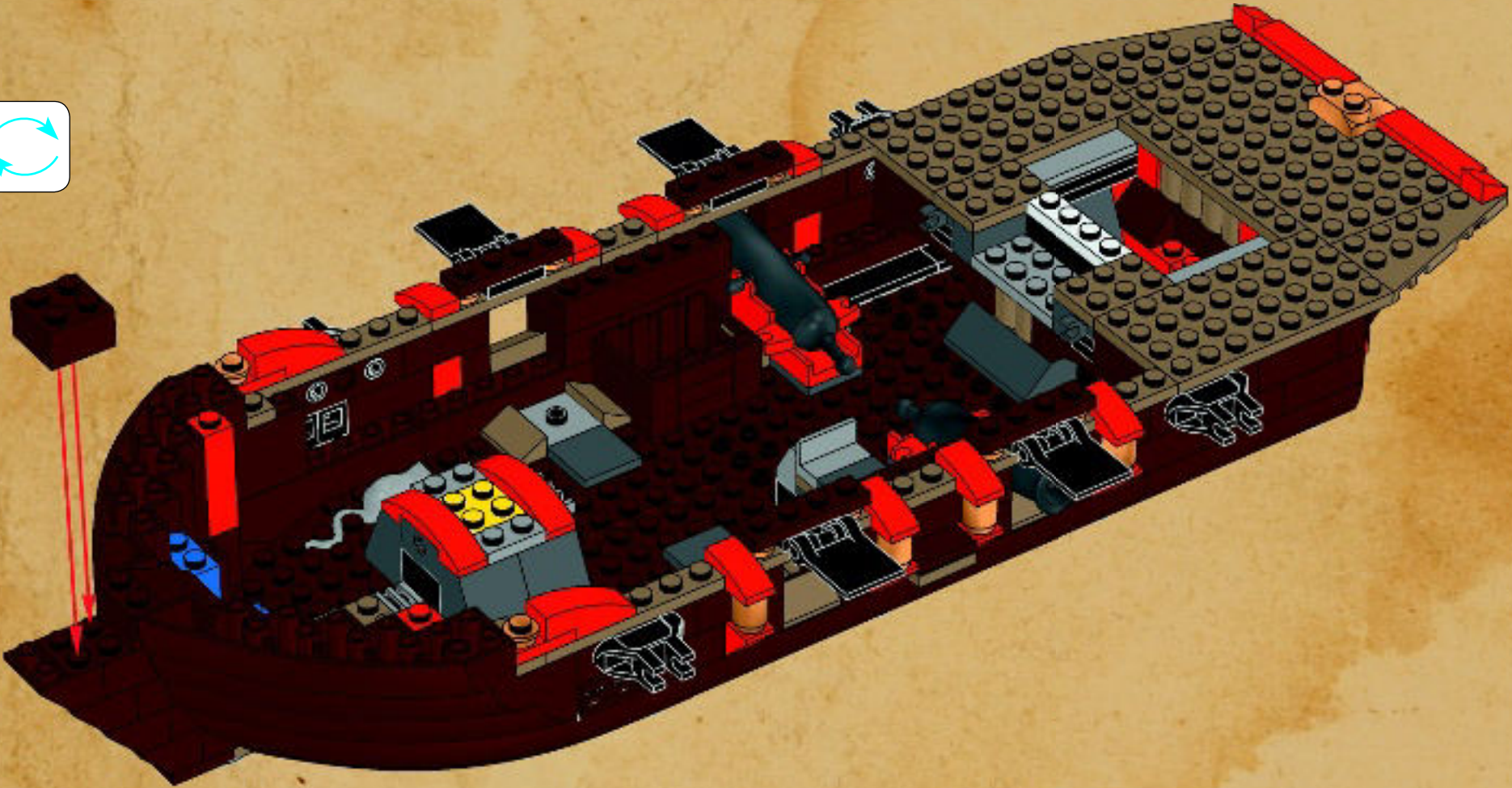



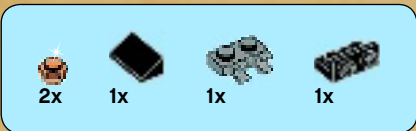

# 56

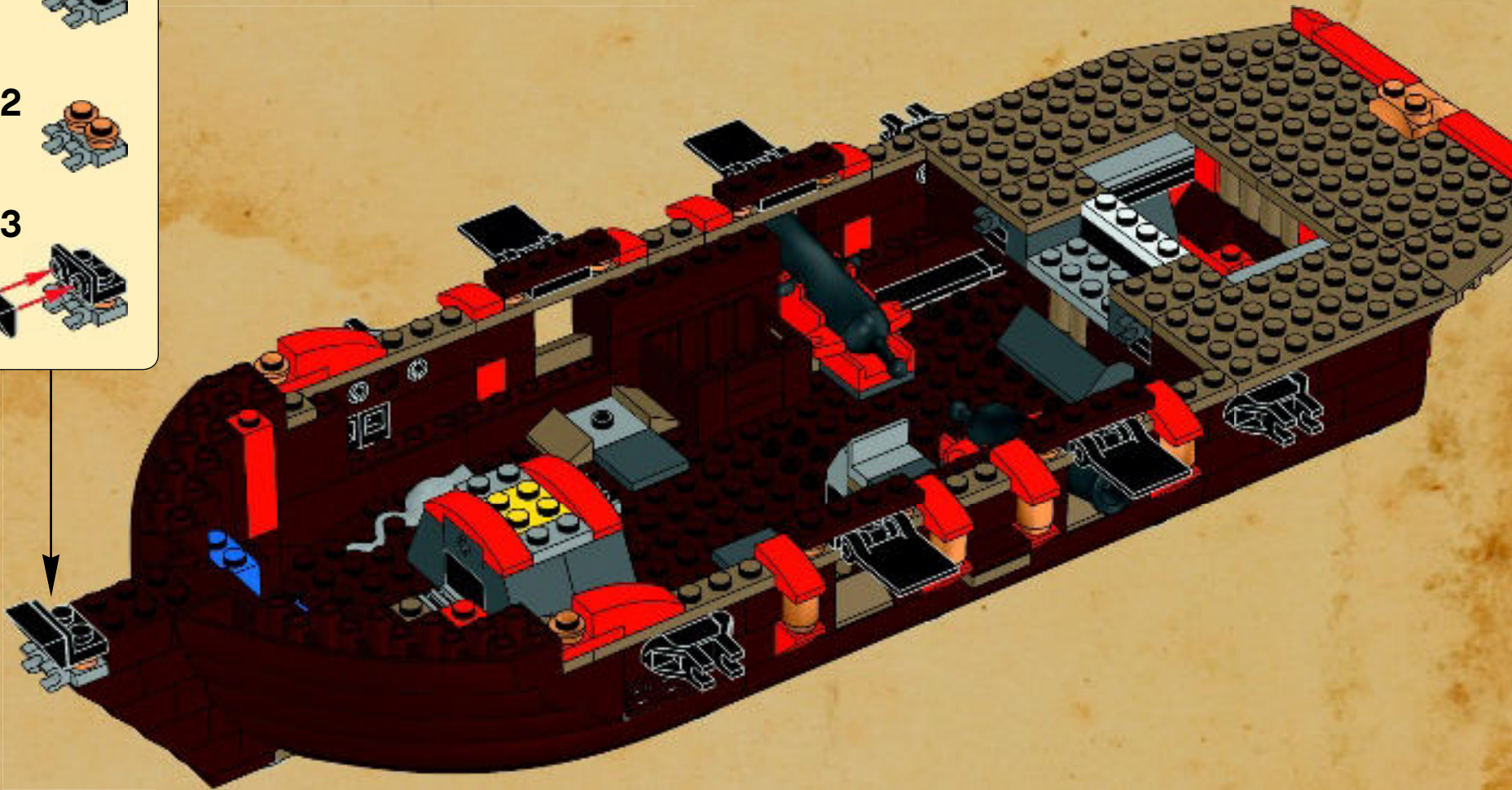





1x

57

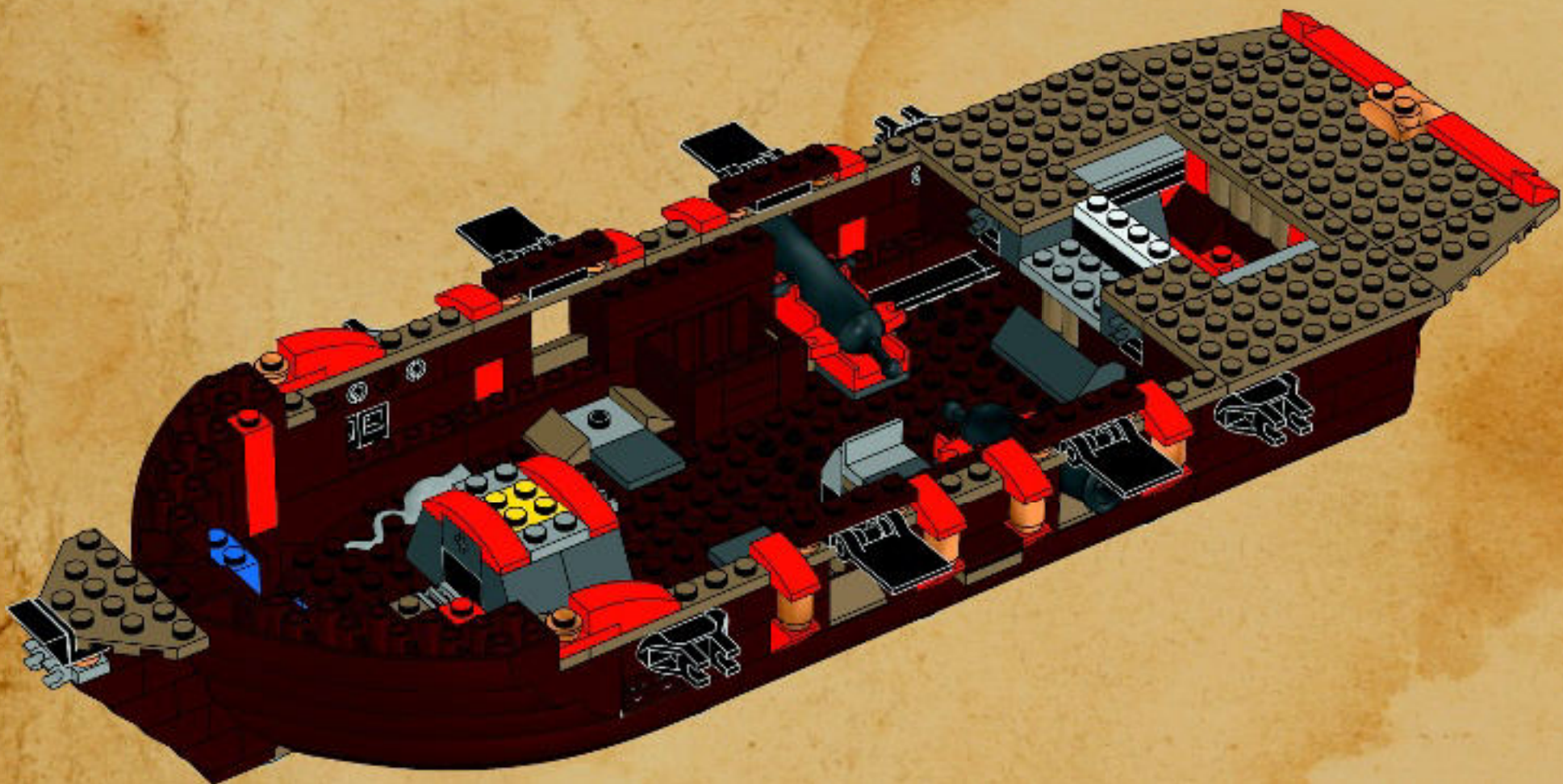





58

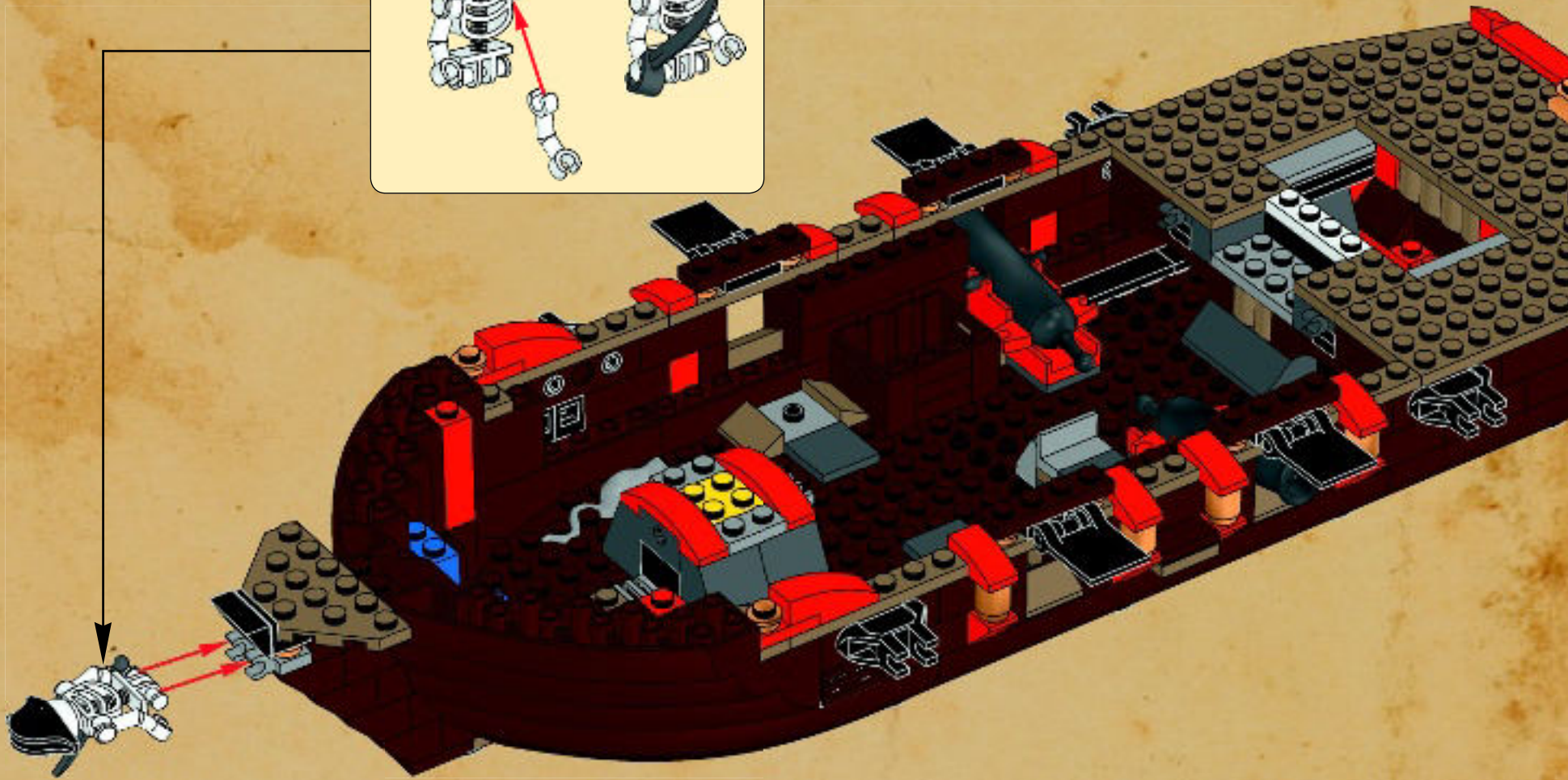
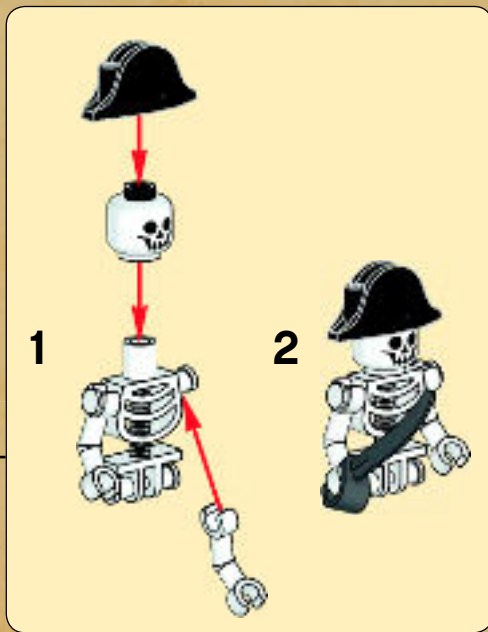



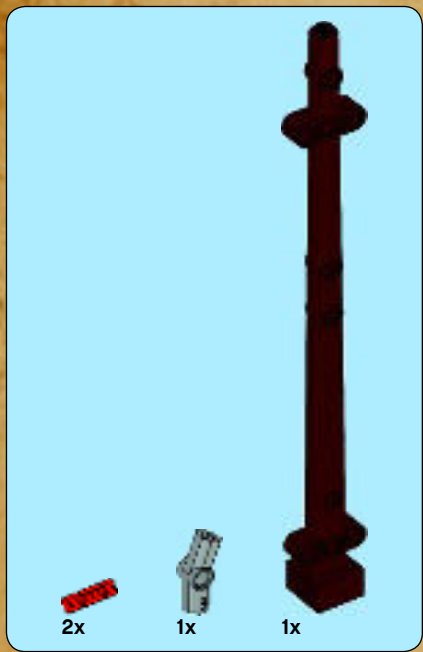

59

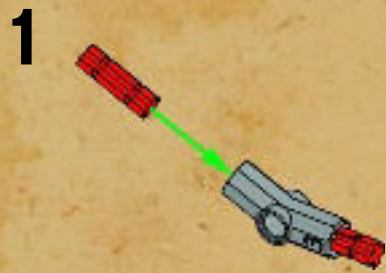



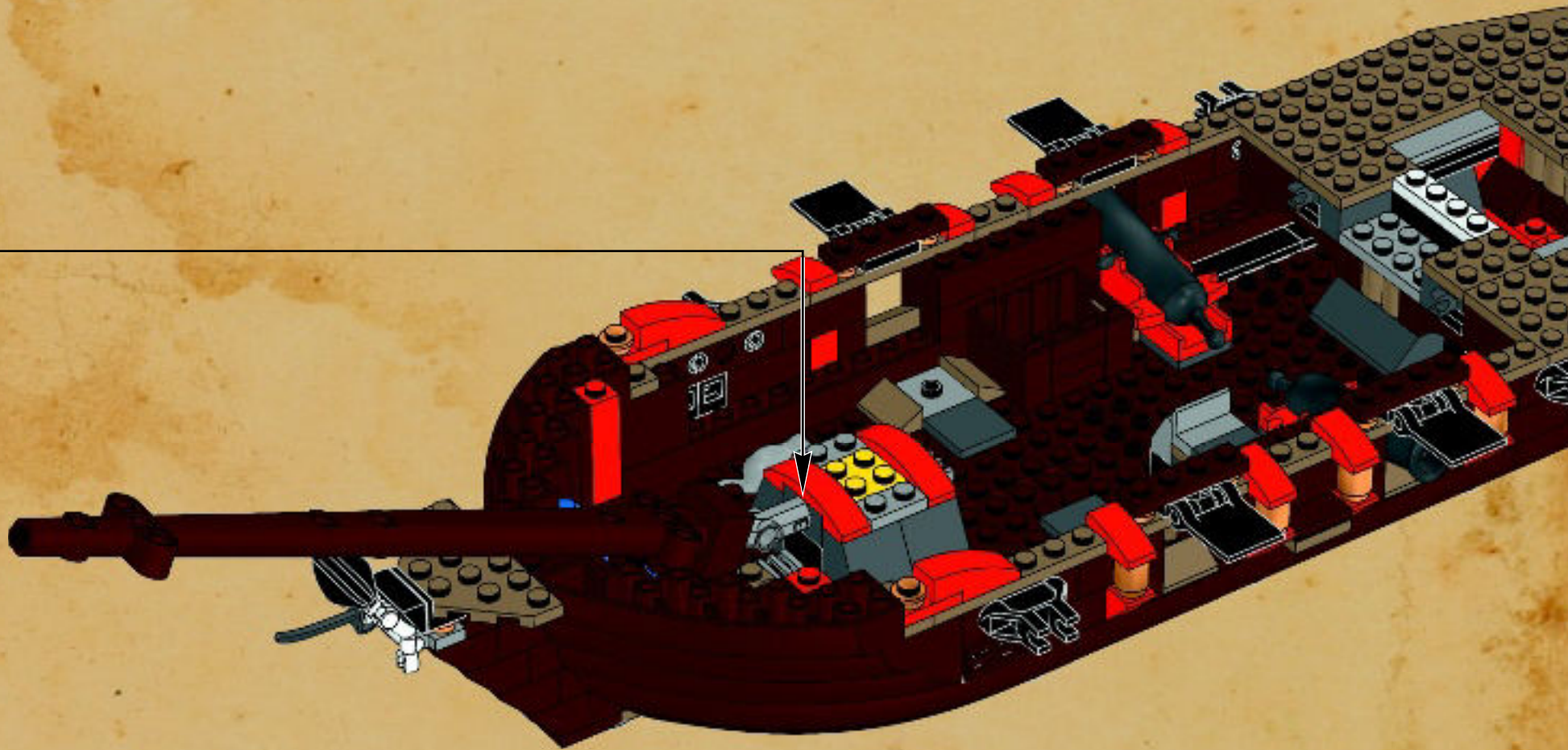



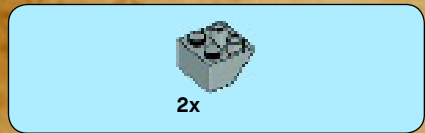

60

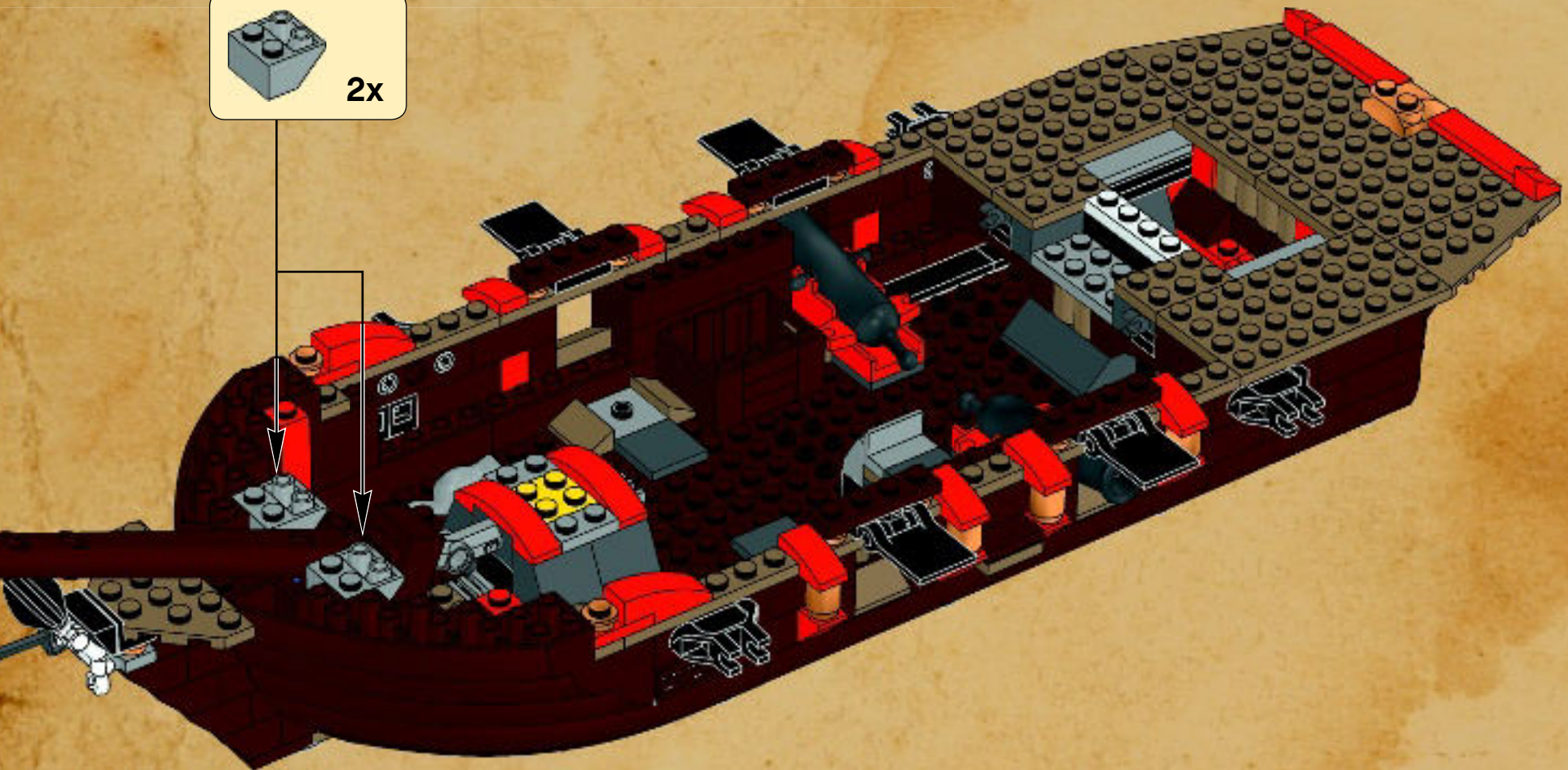
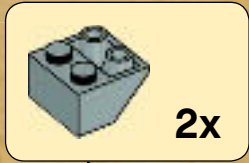



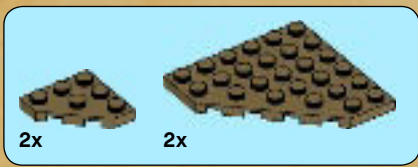

61

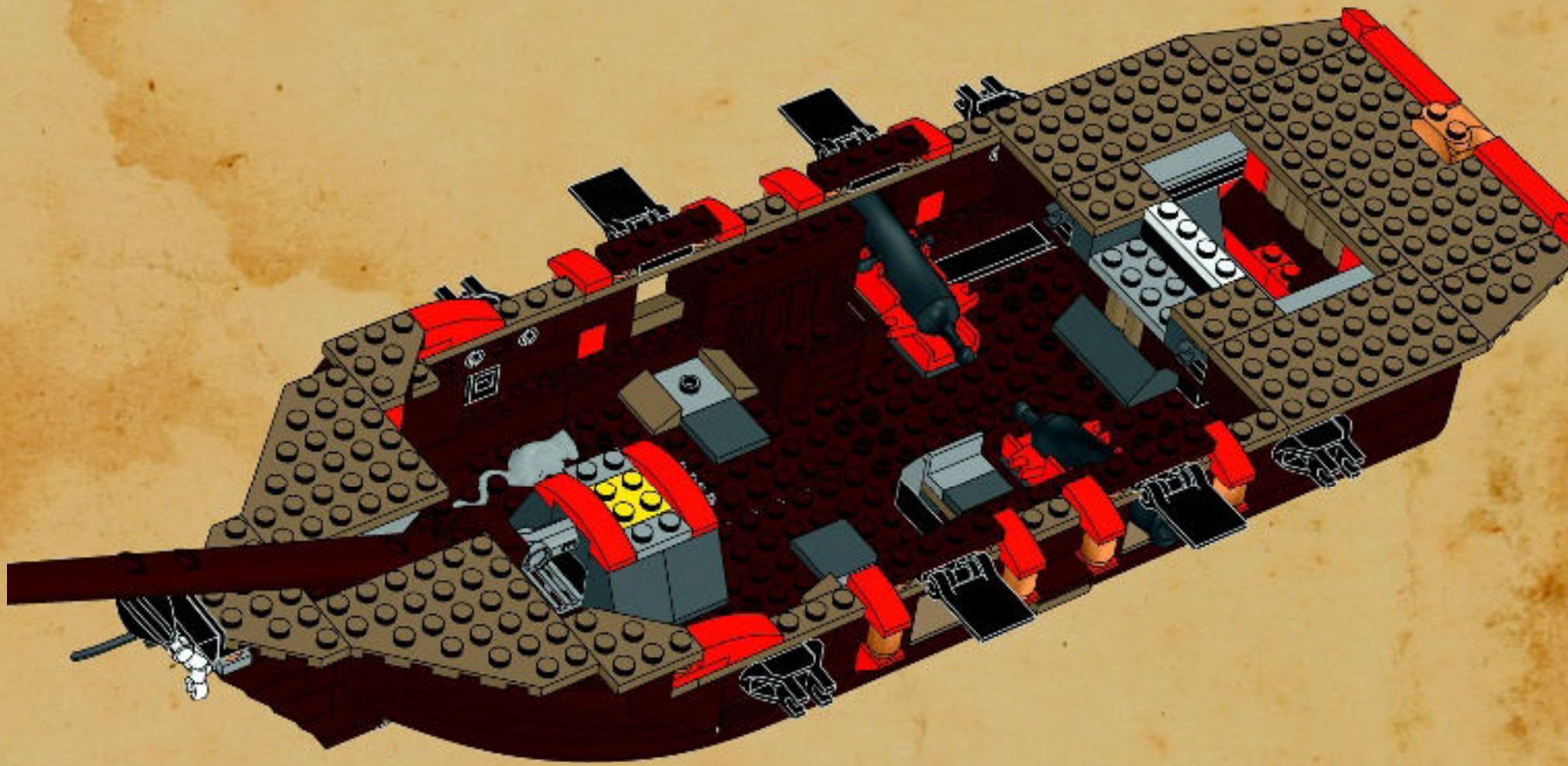





62

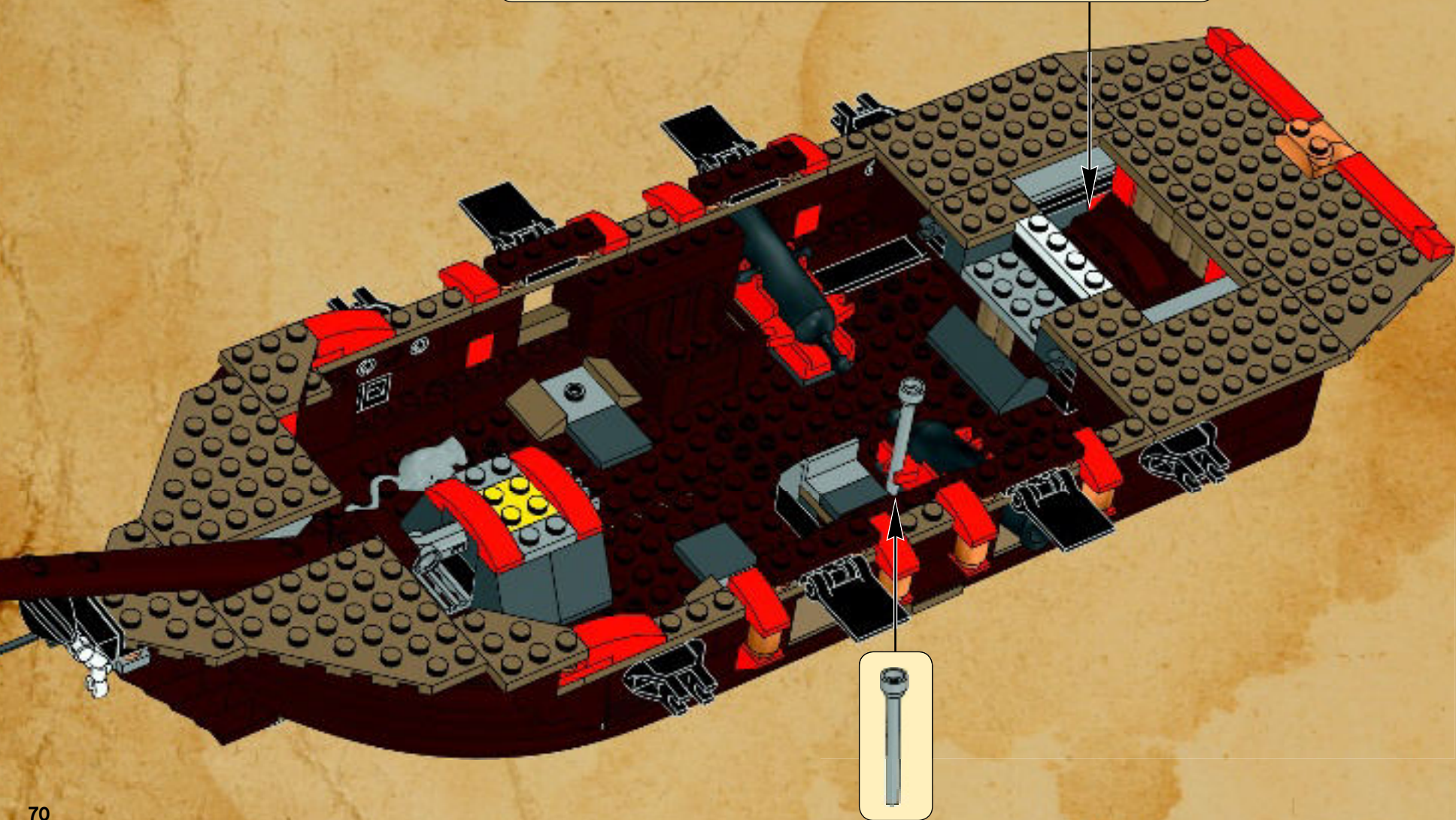



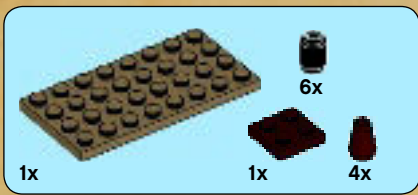

63

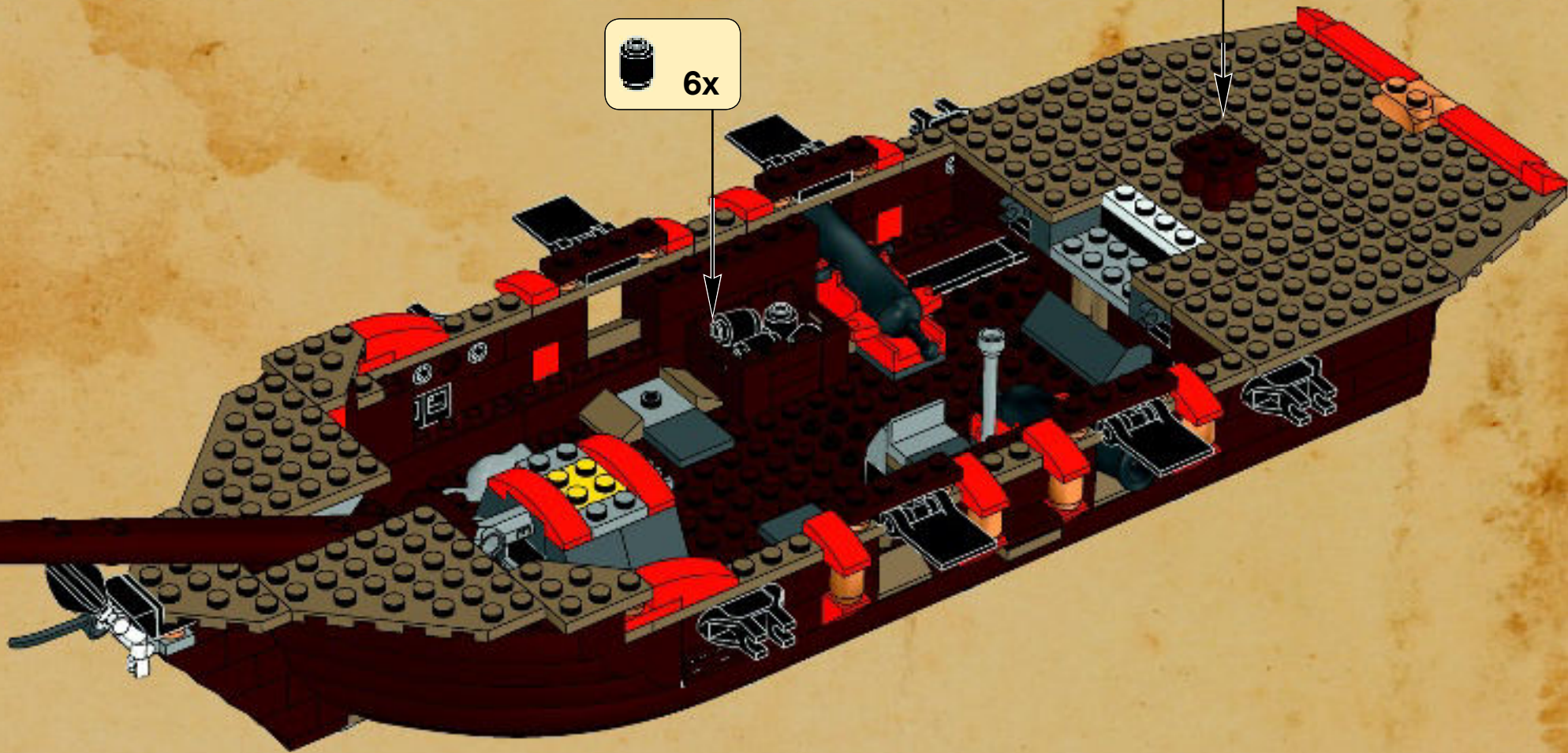
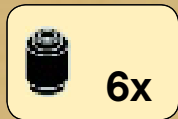
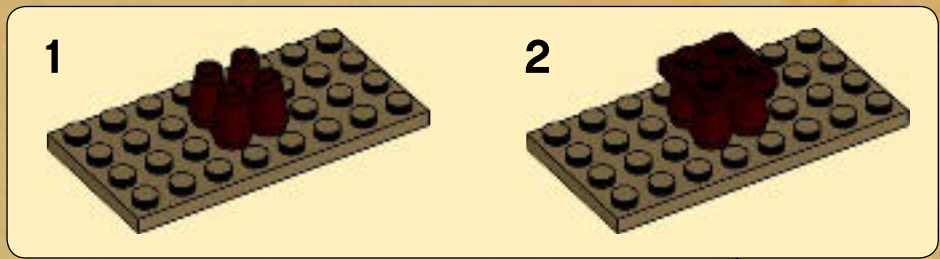



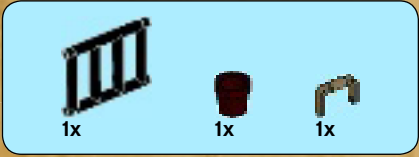
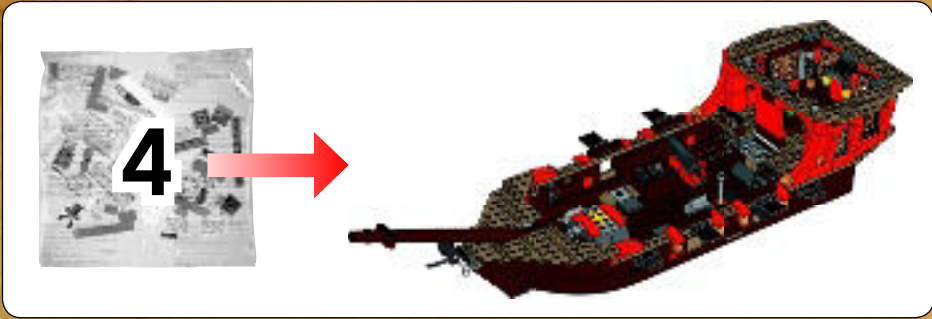

64

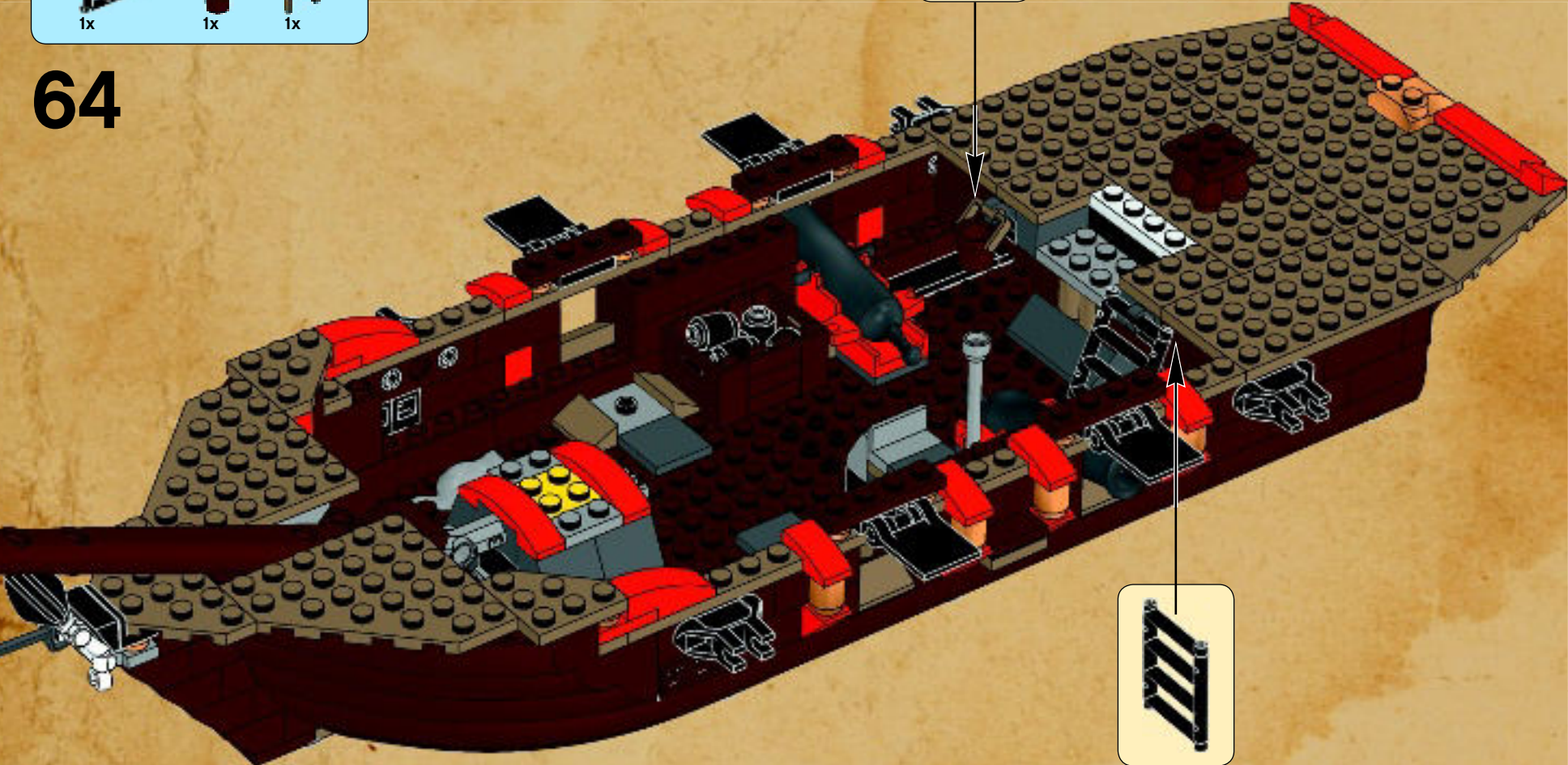





# 65

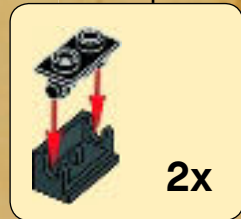
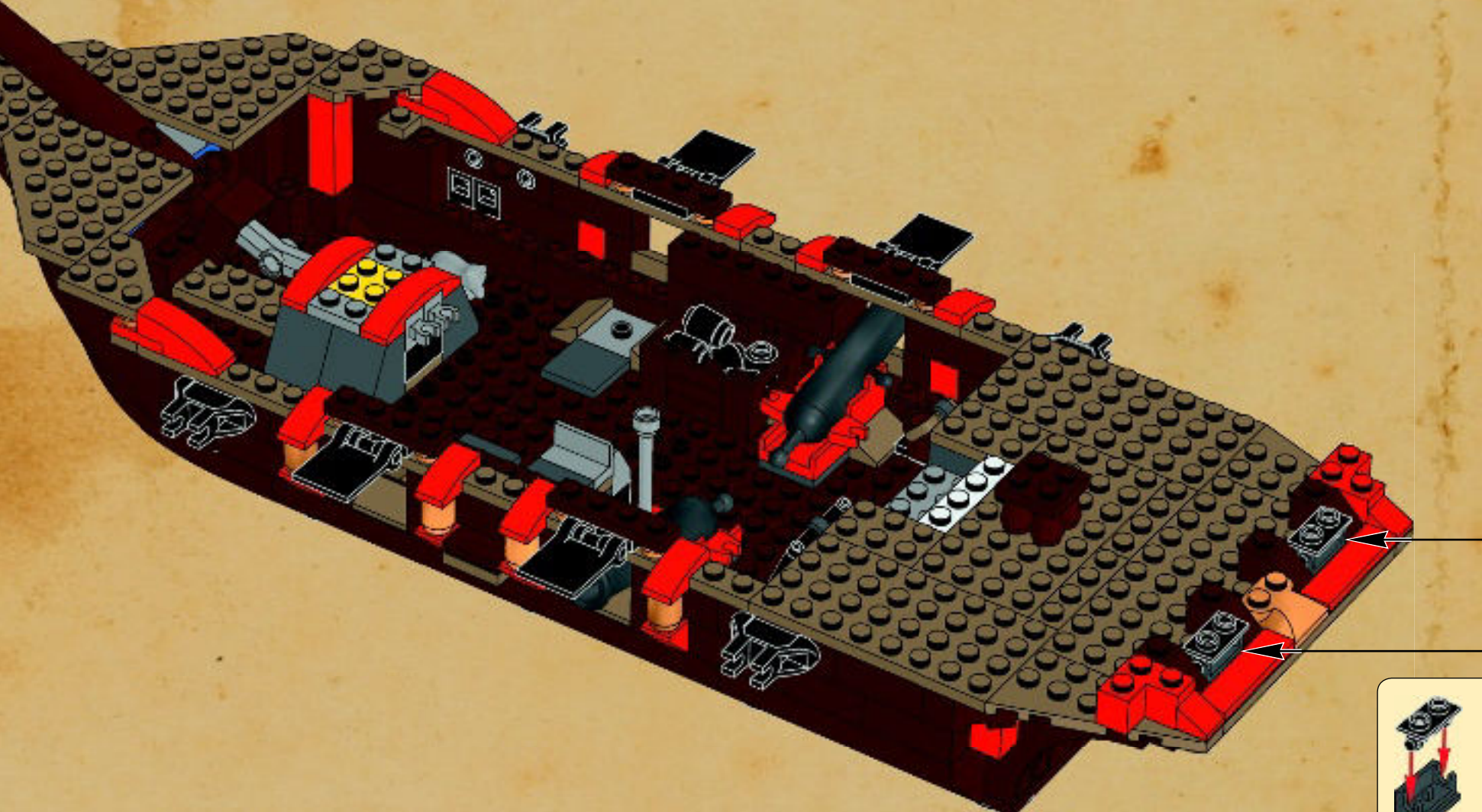





1x



2x

# 66

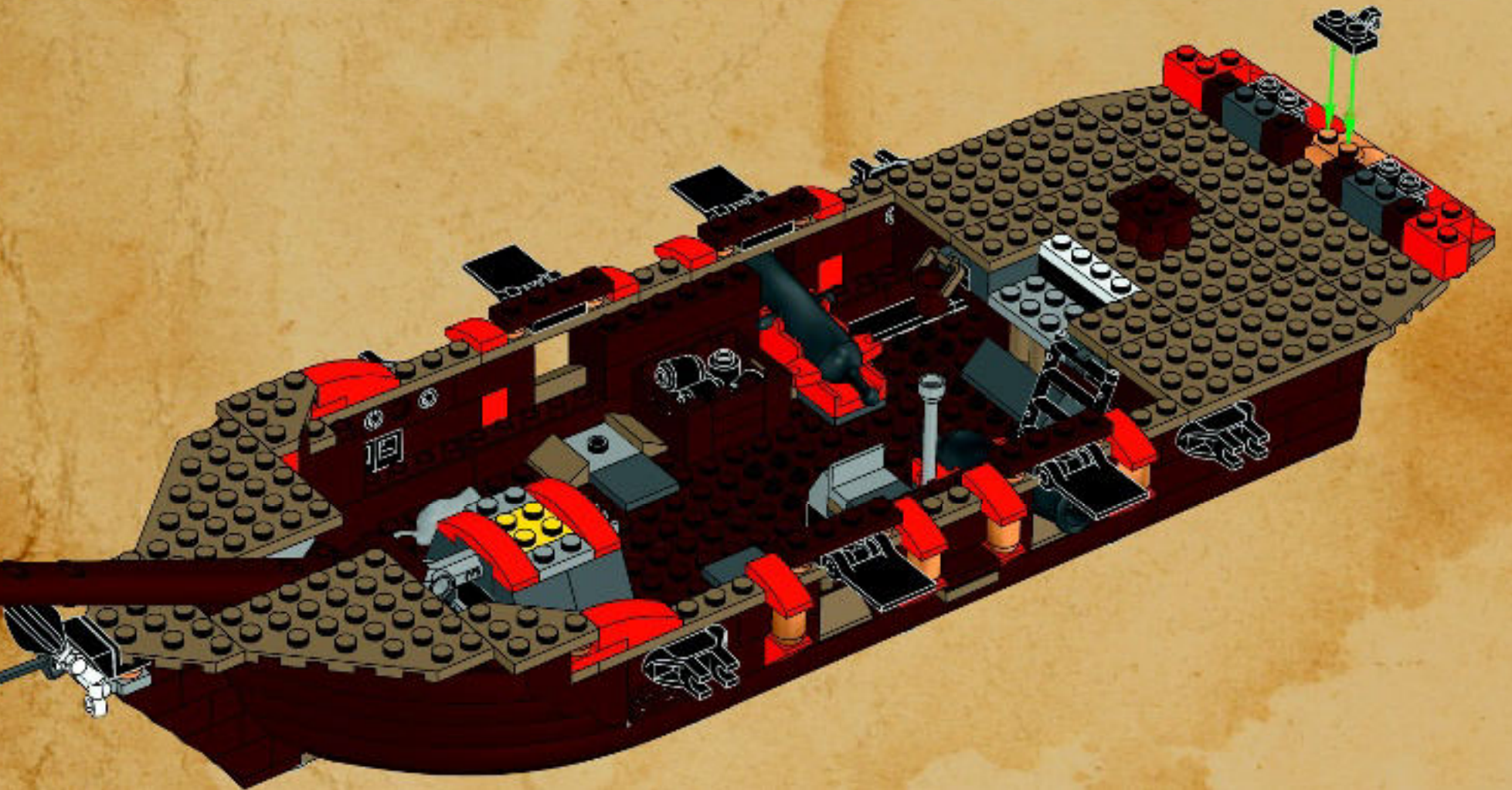



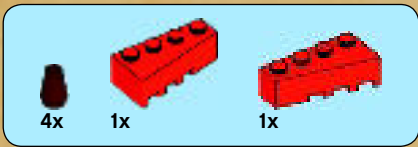

67

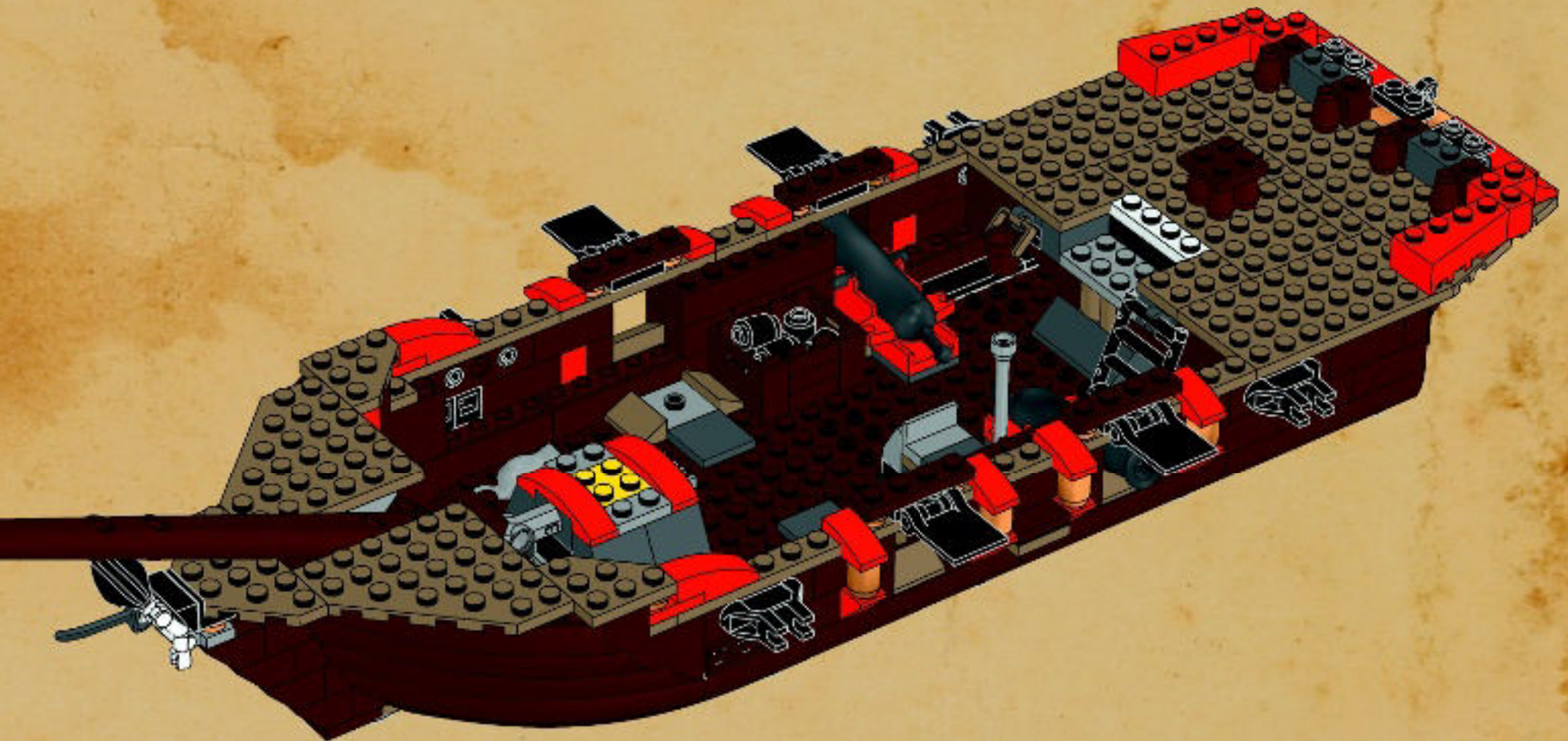





2x



2x

# 68

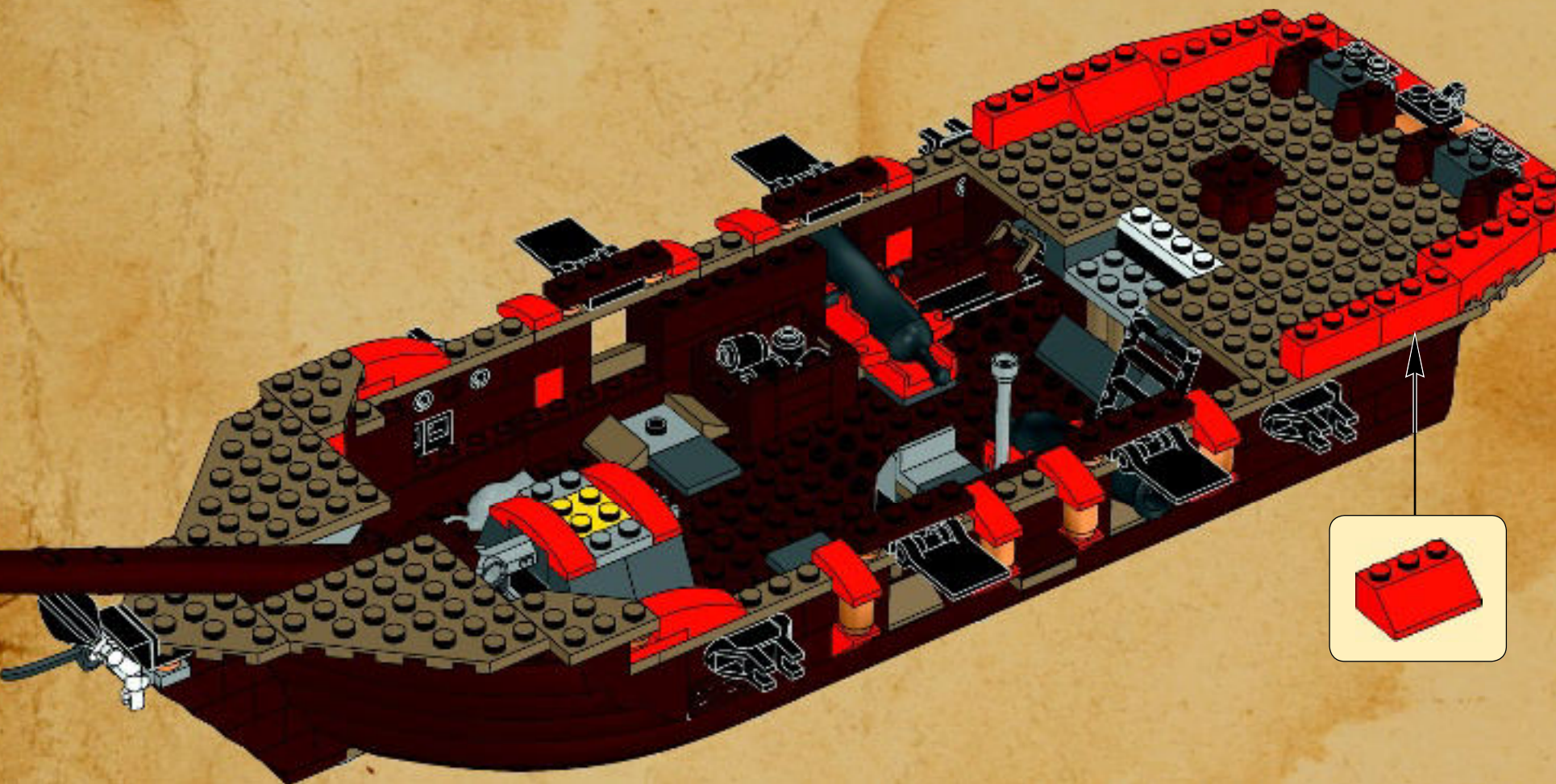





2x

69

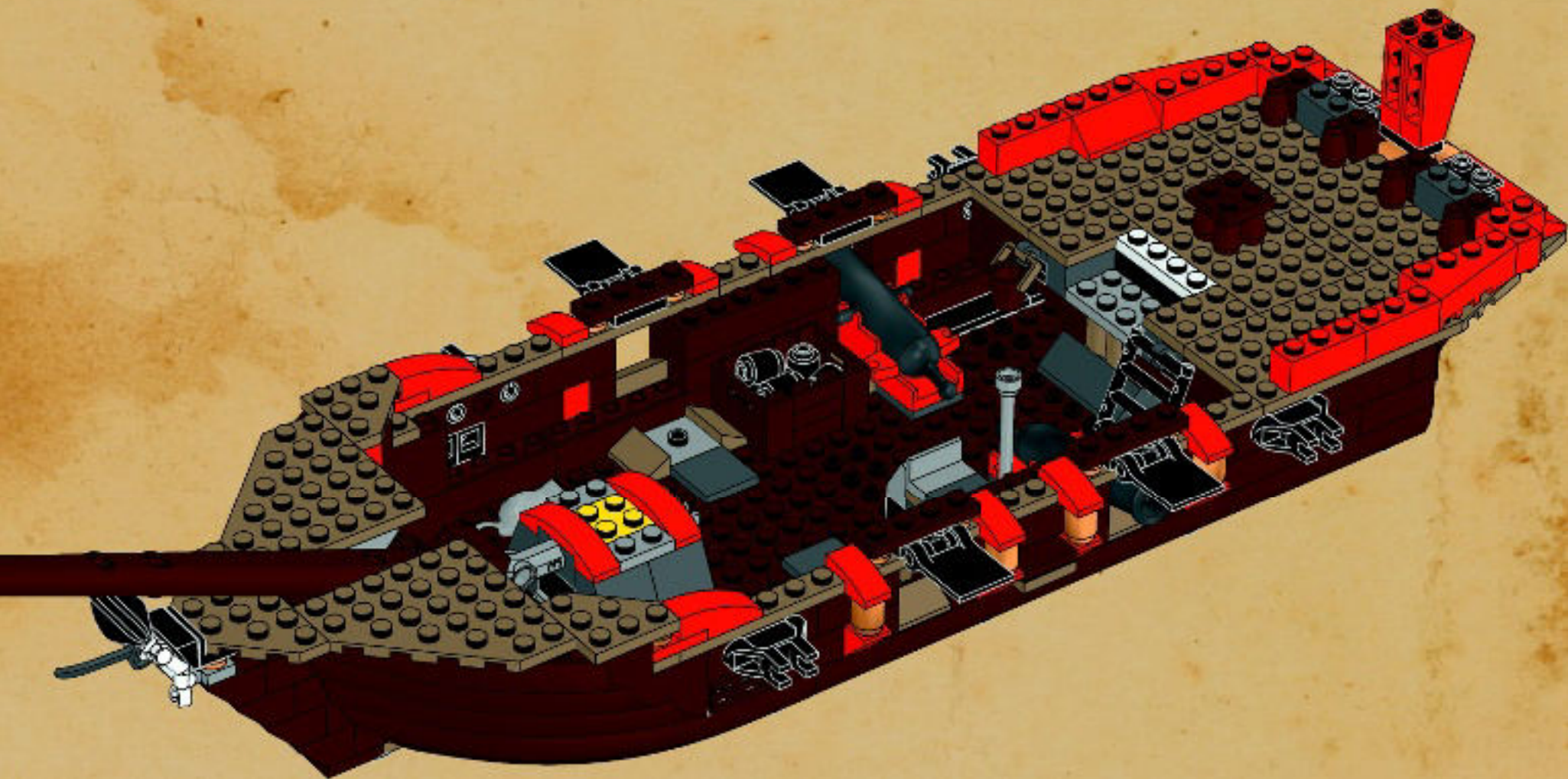





70

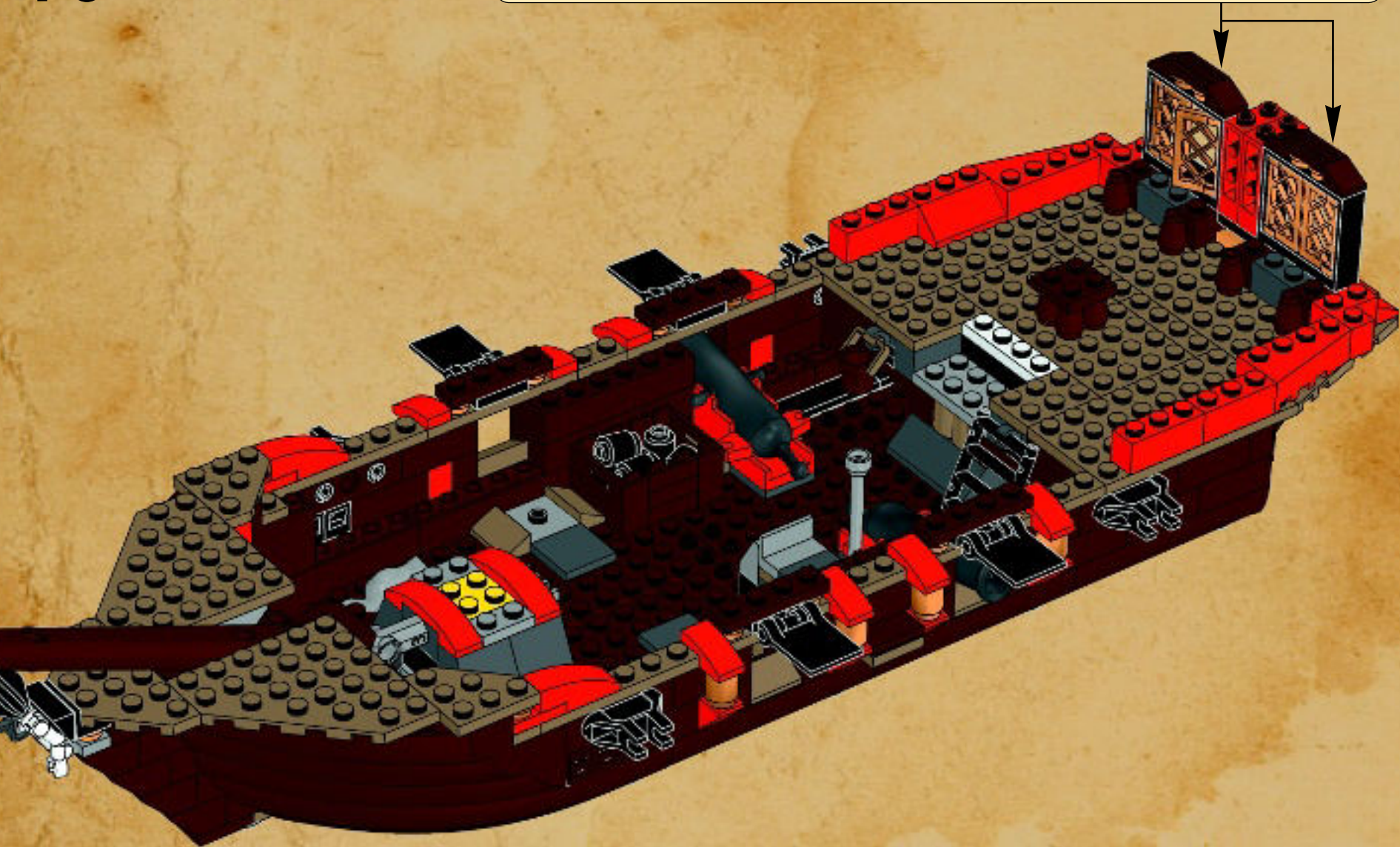



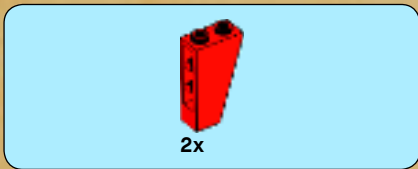

71

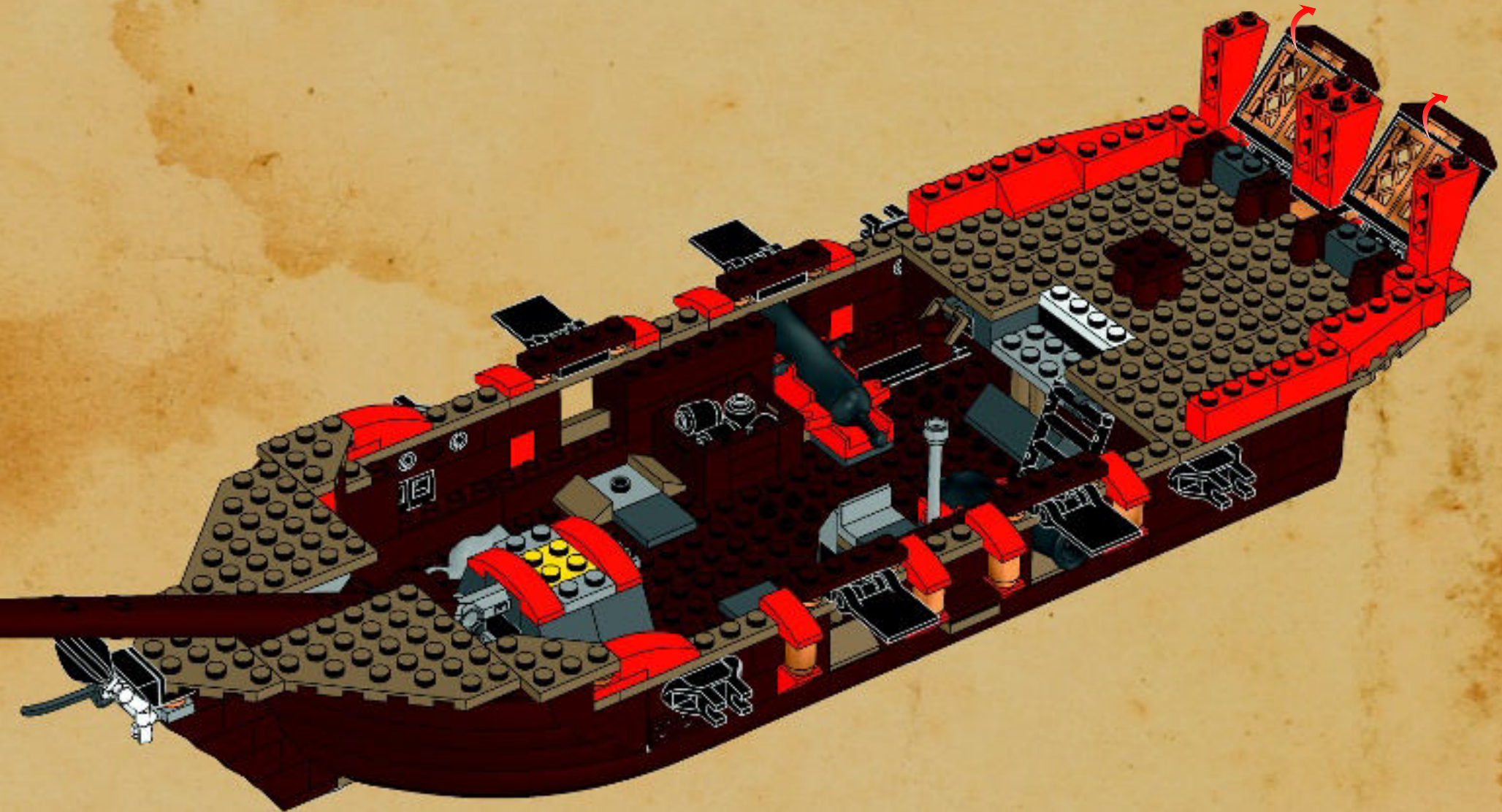





72

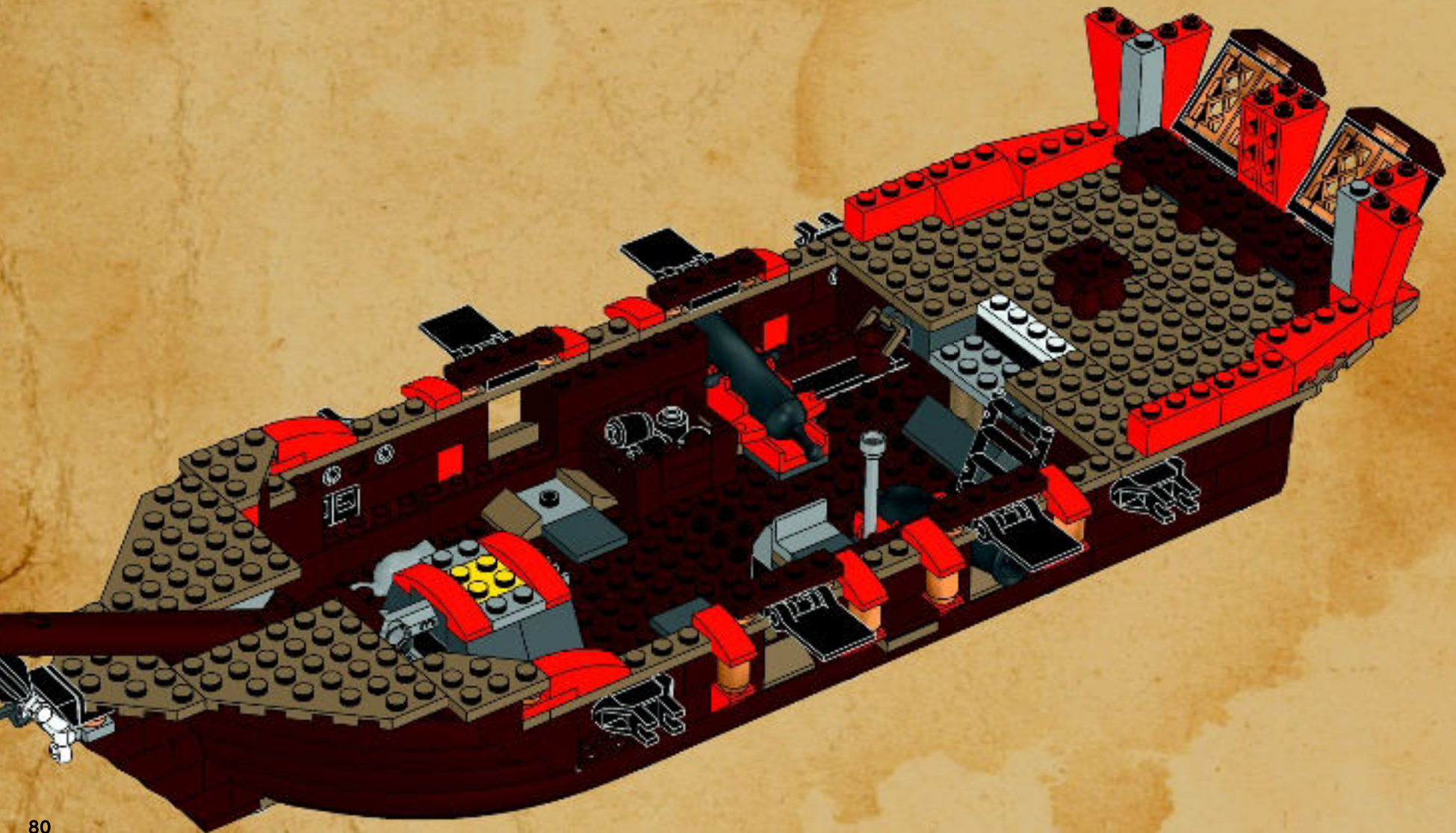





73

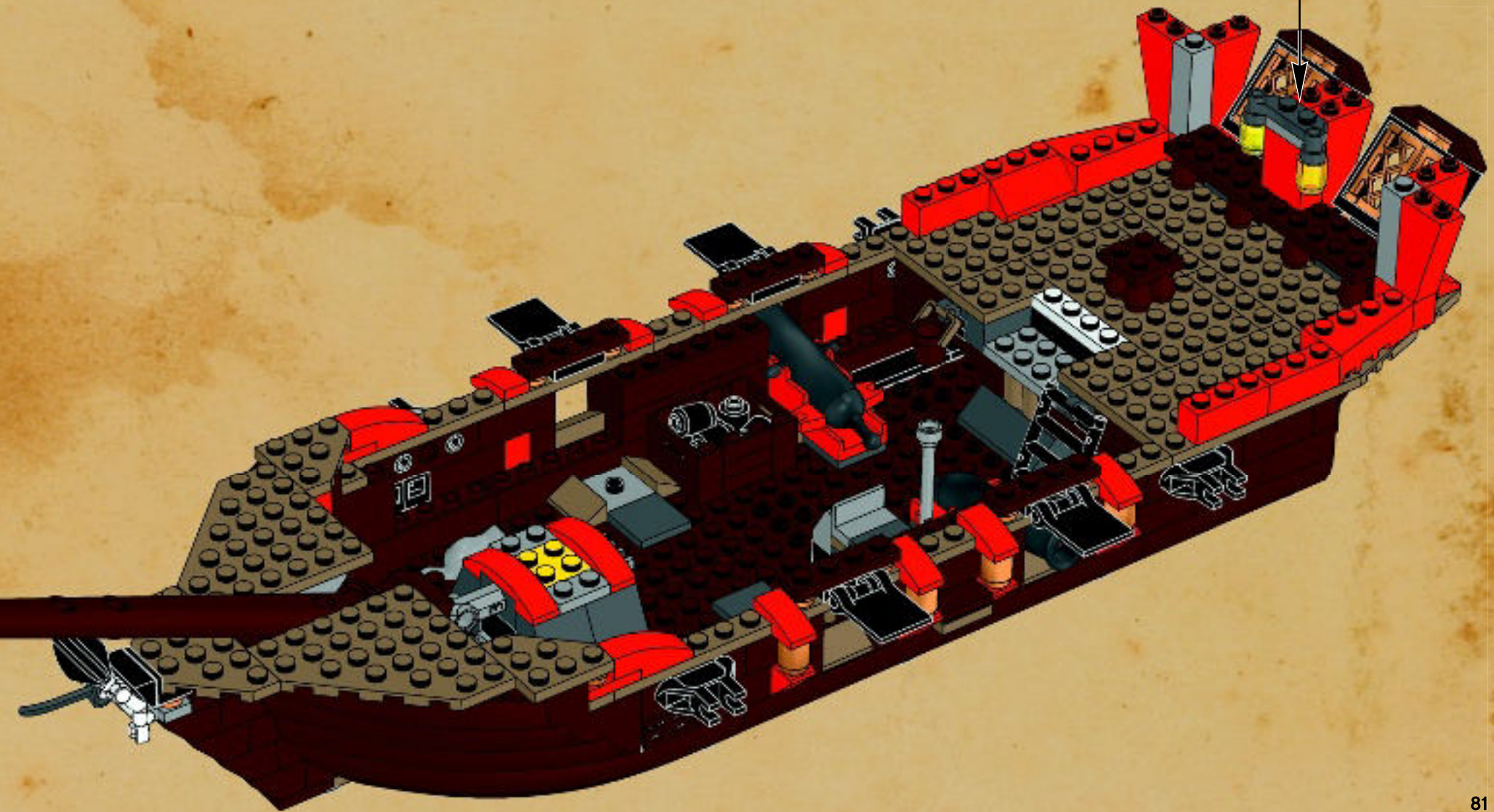



1x  2x 

74

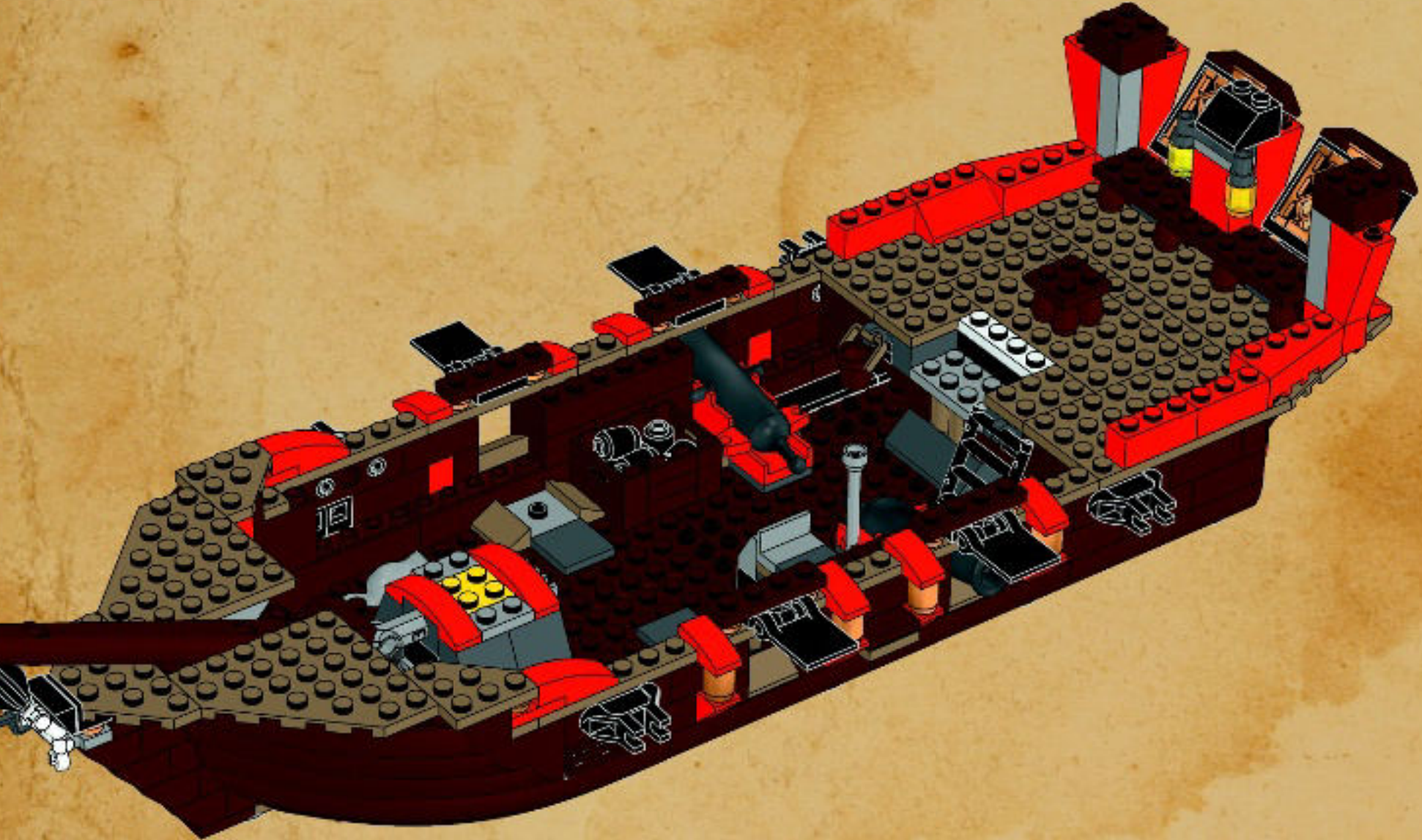



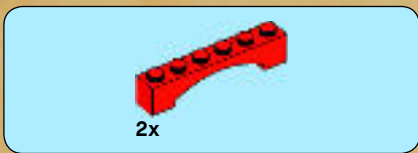

75

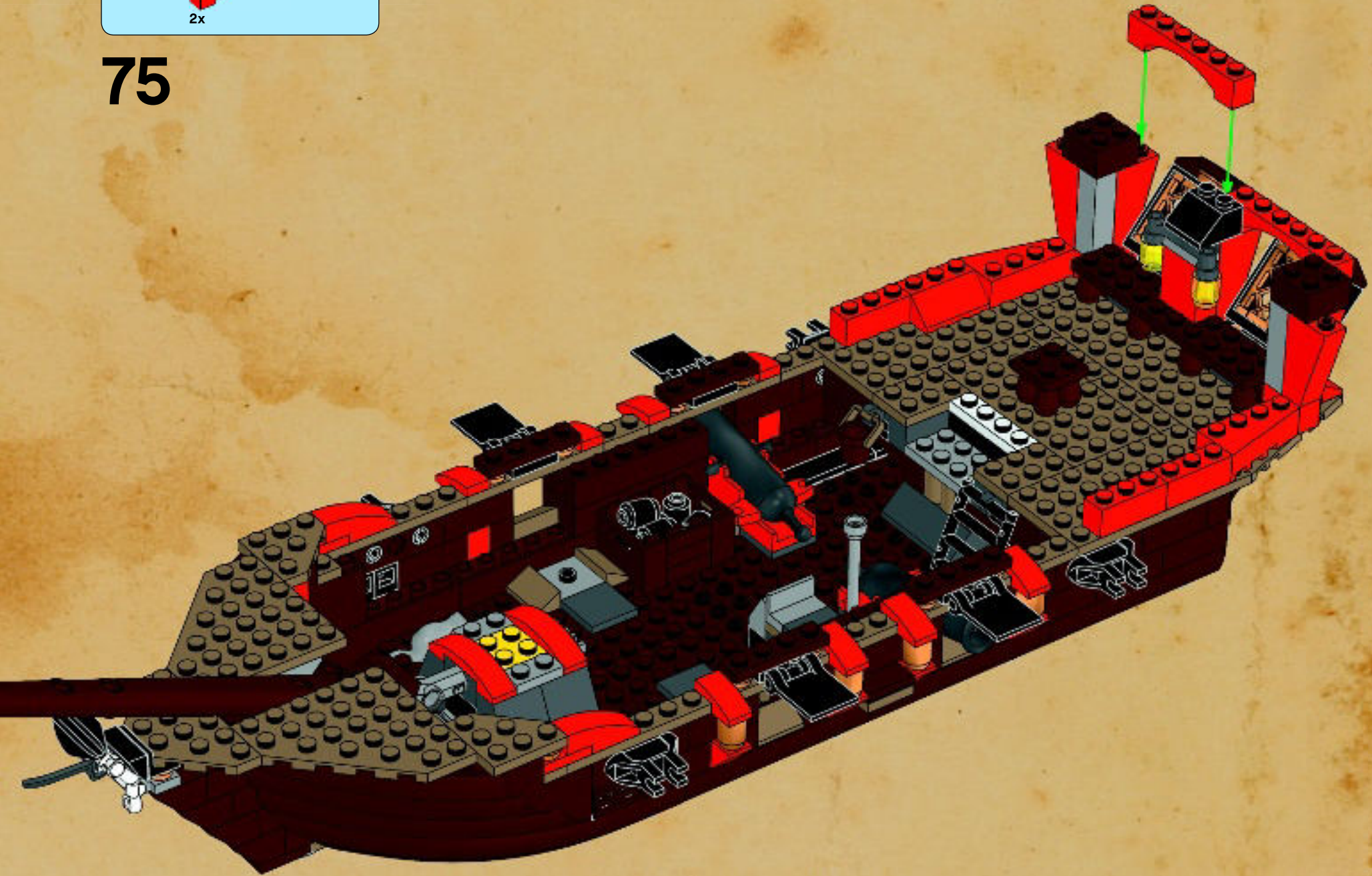



- 1x 
- 1x 
- 1x 
- 1x 

# 76

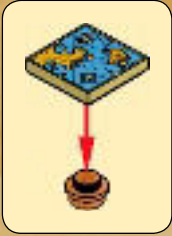
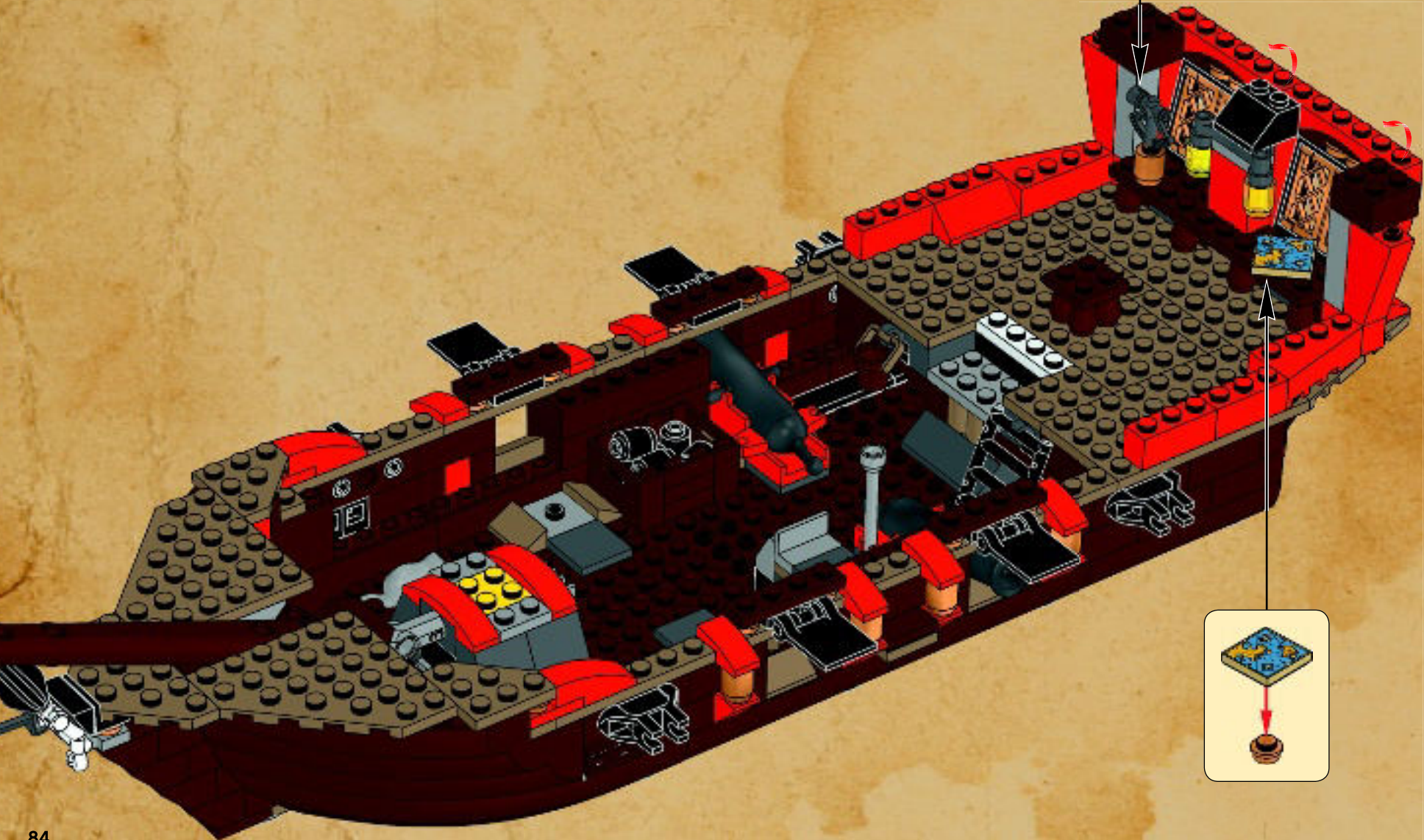





77

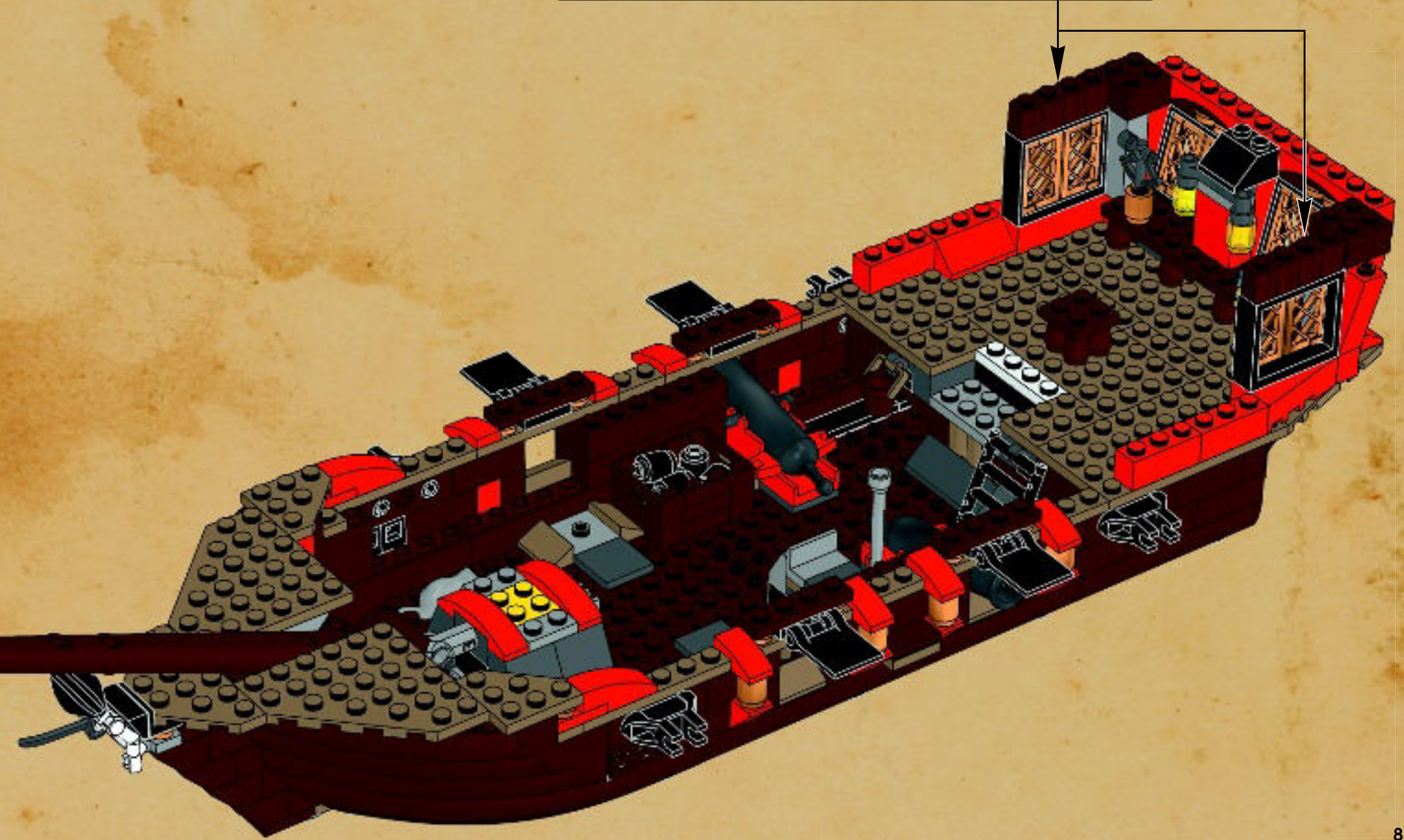
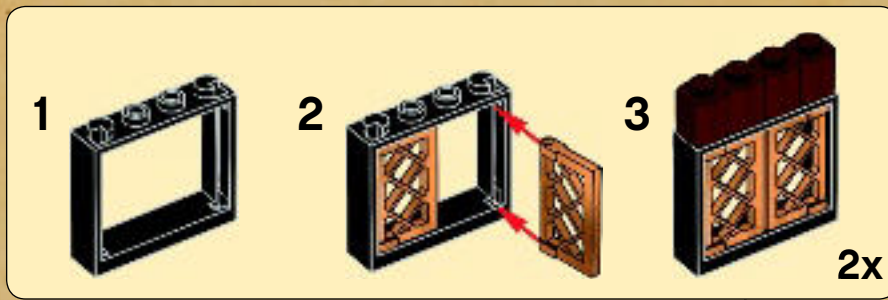





78

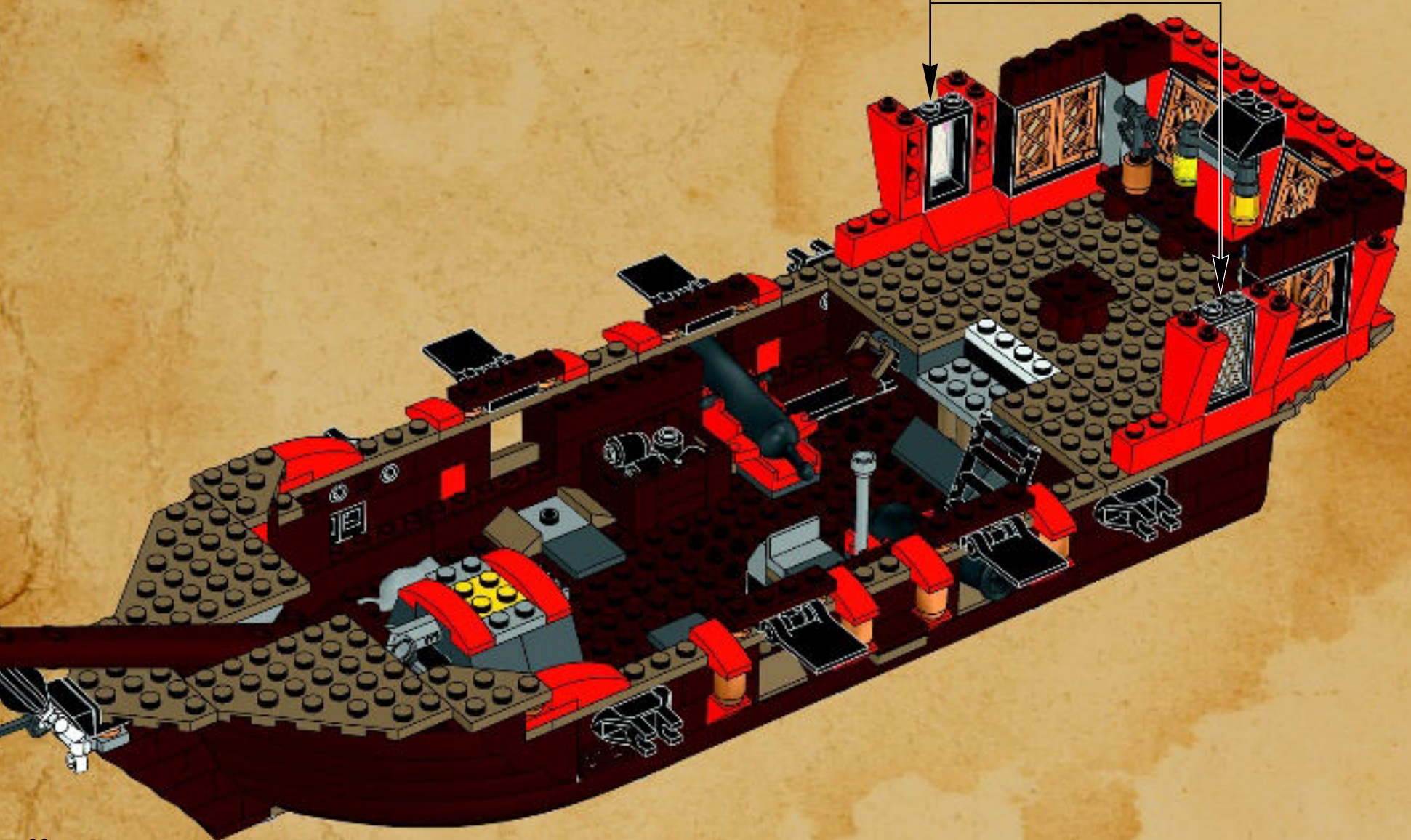
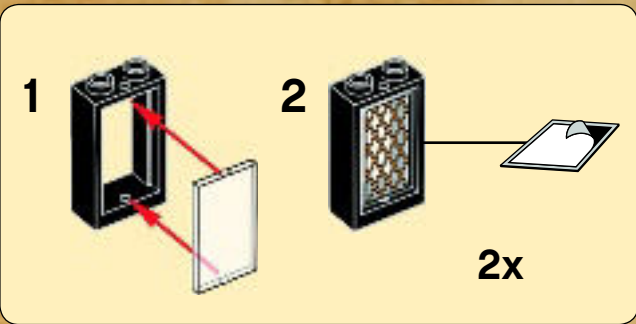





79

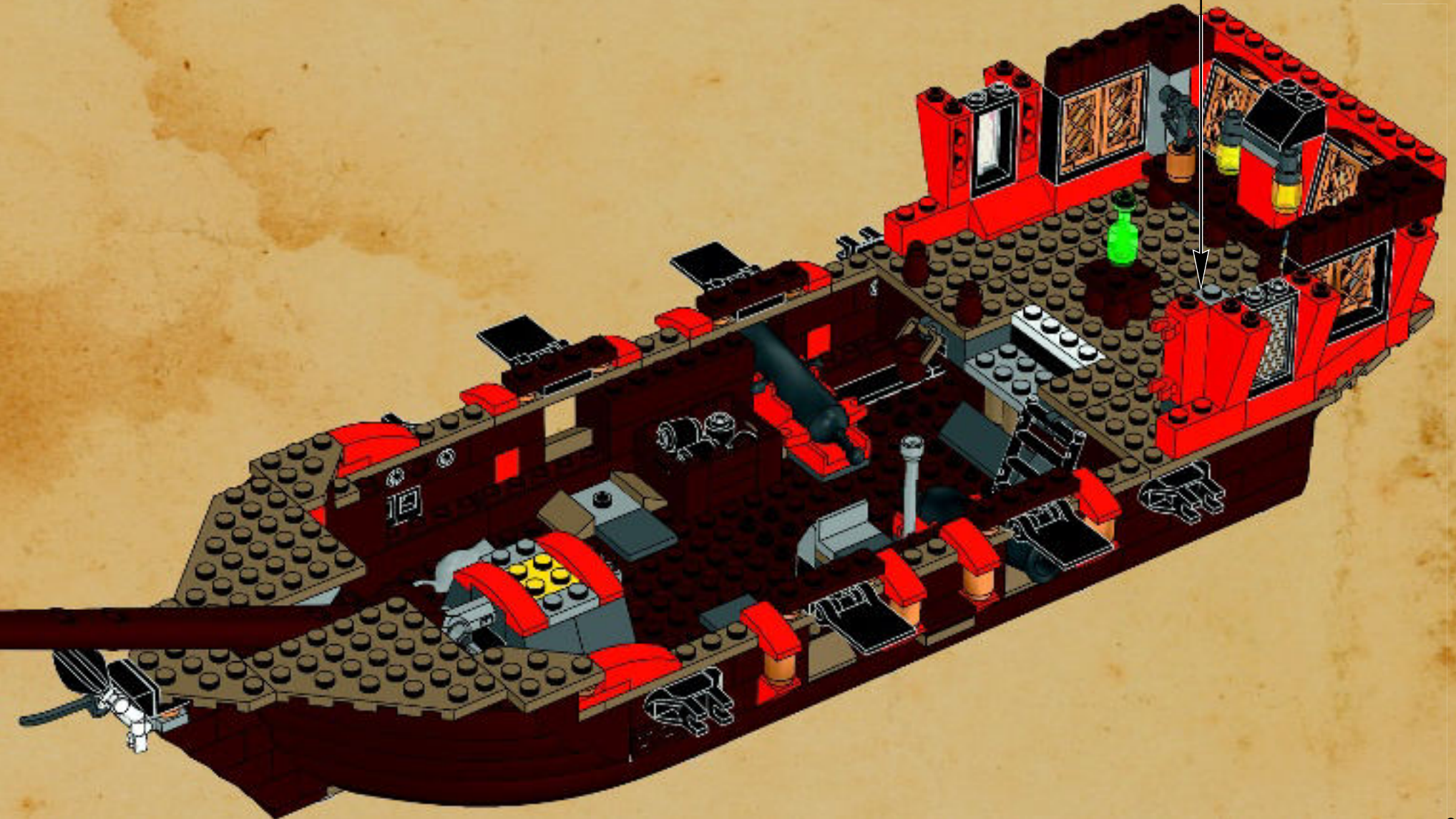
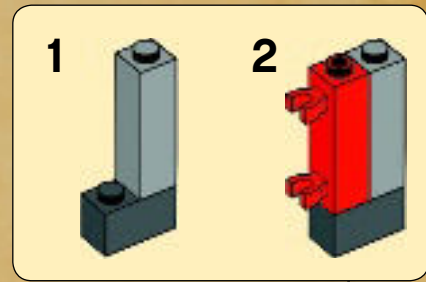





80

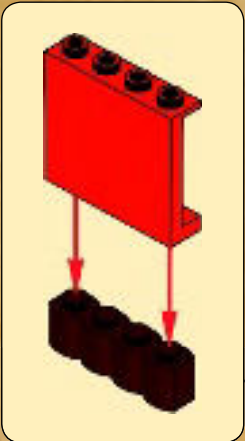



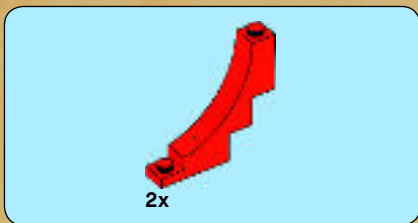



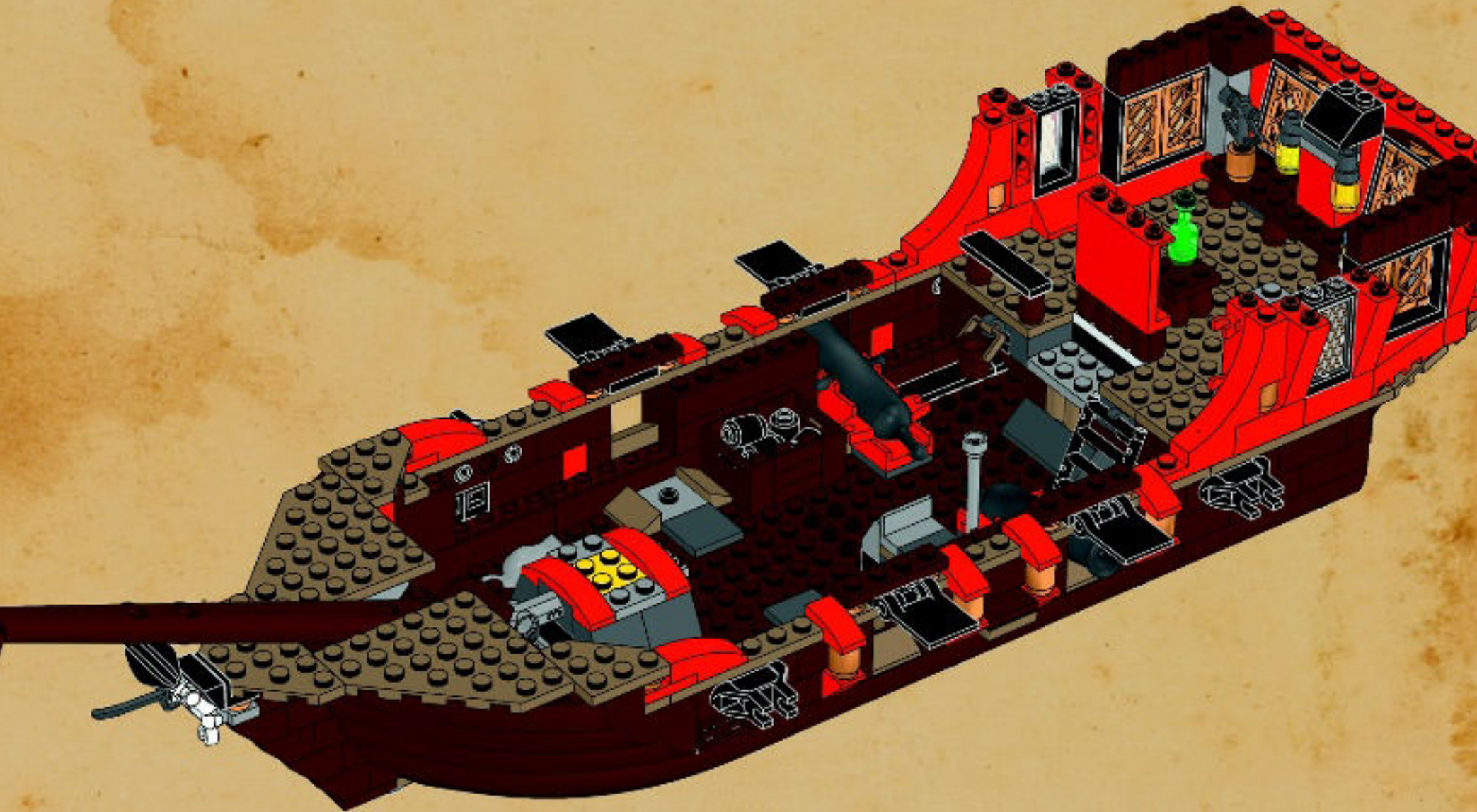

81





2x  2x 

82





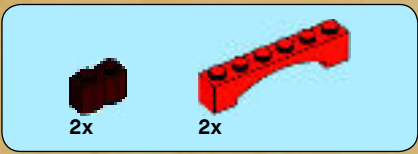

83







2x



2x



2x

# 84

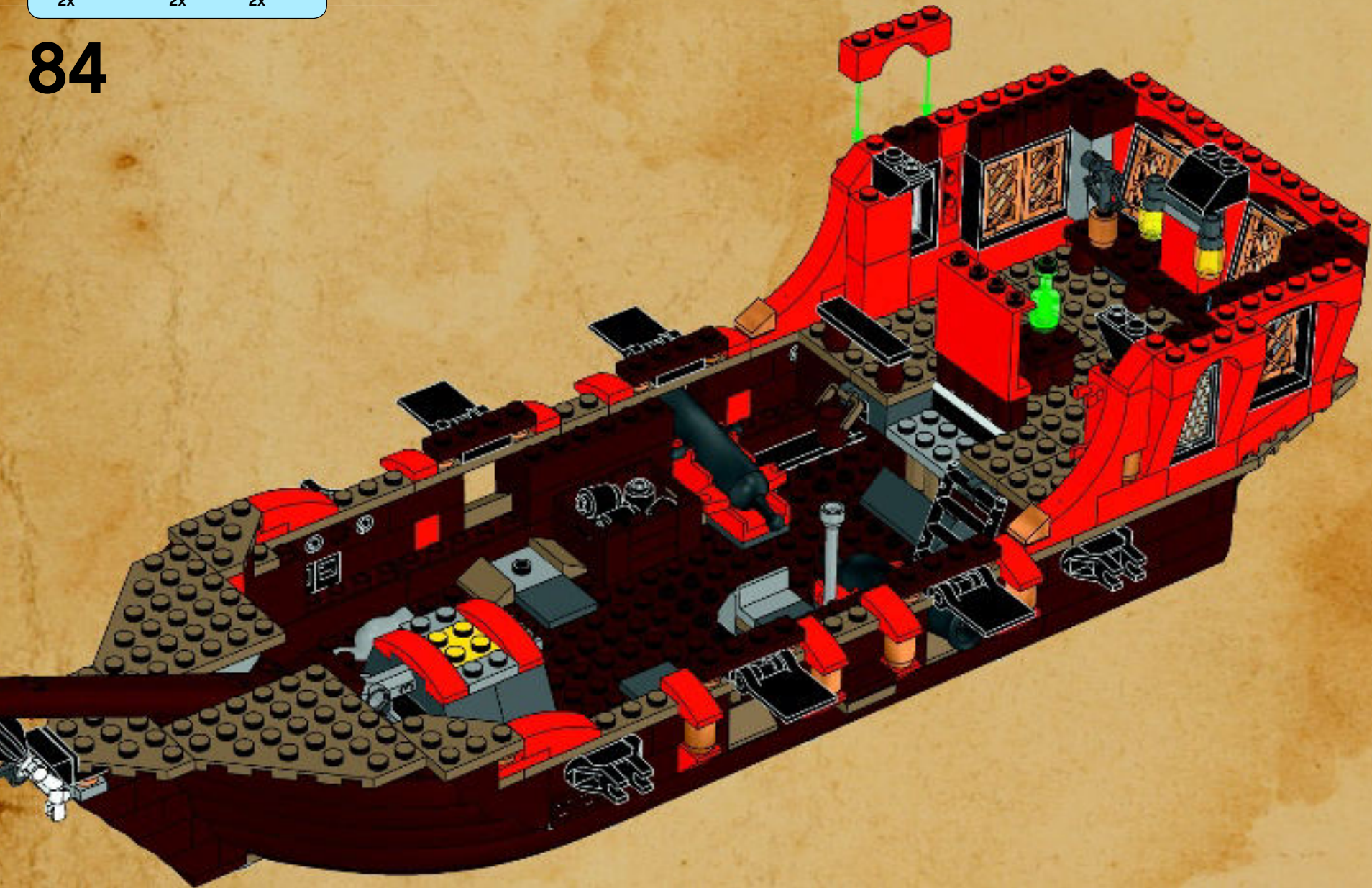



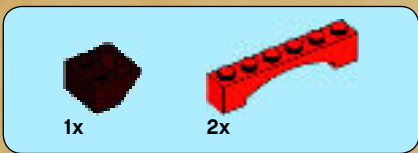

85

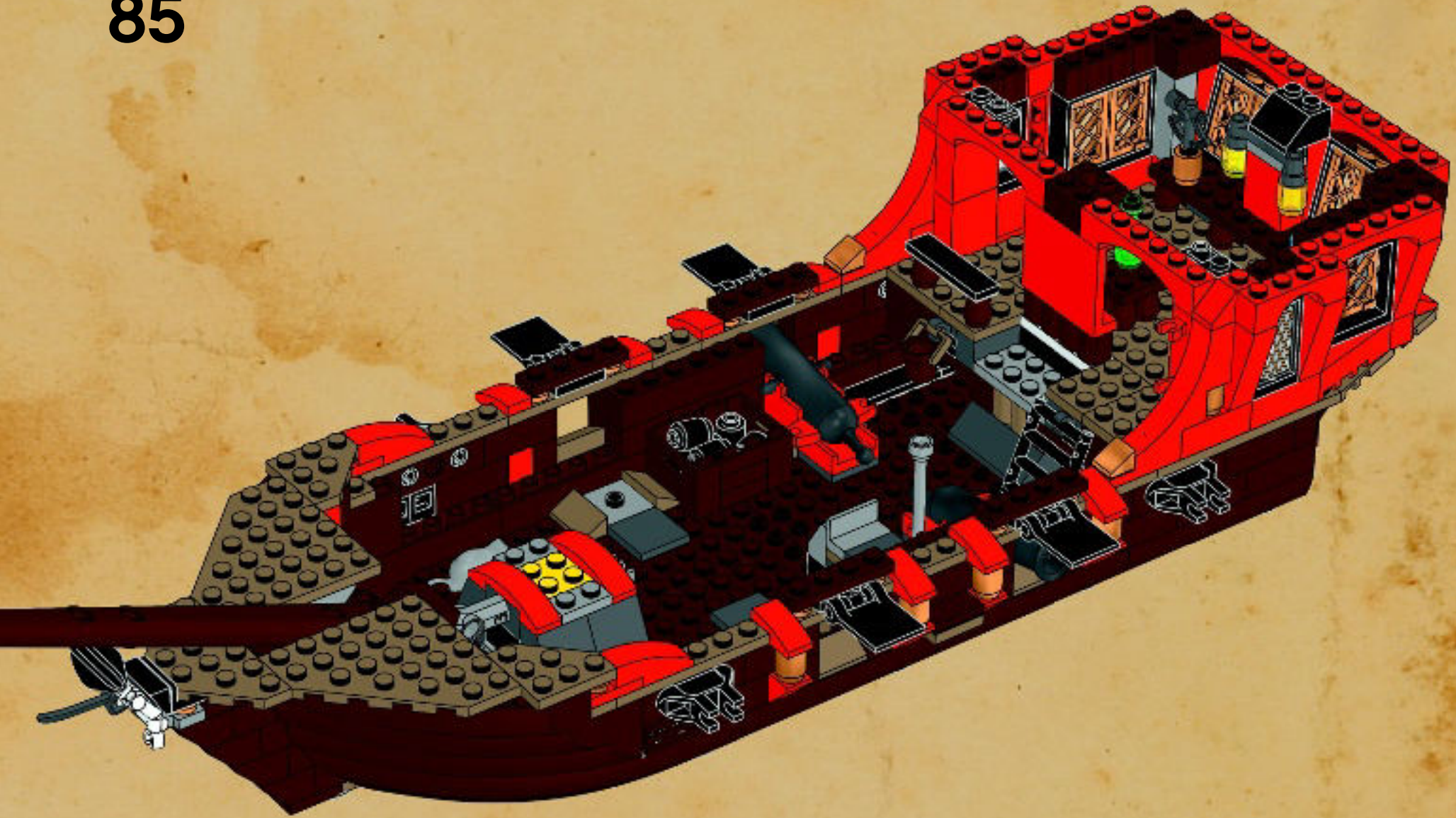





2x



2x

# 86

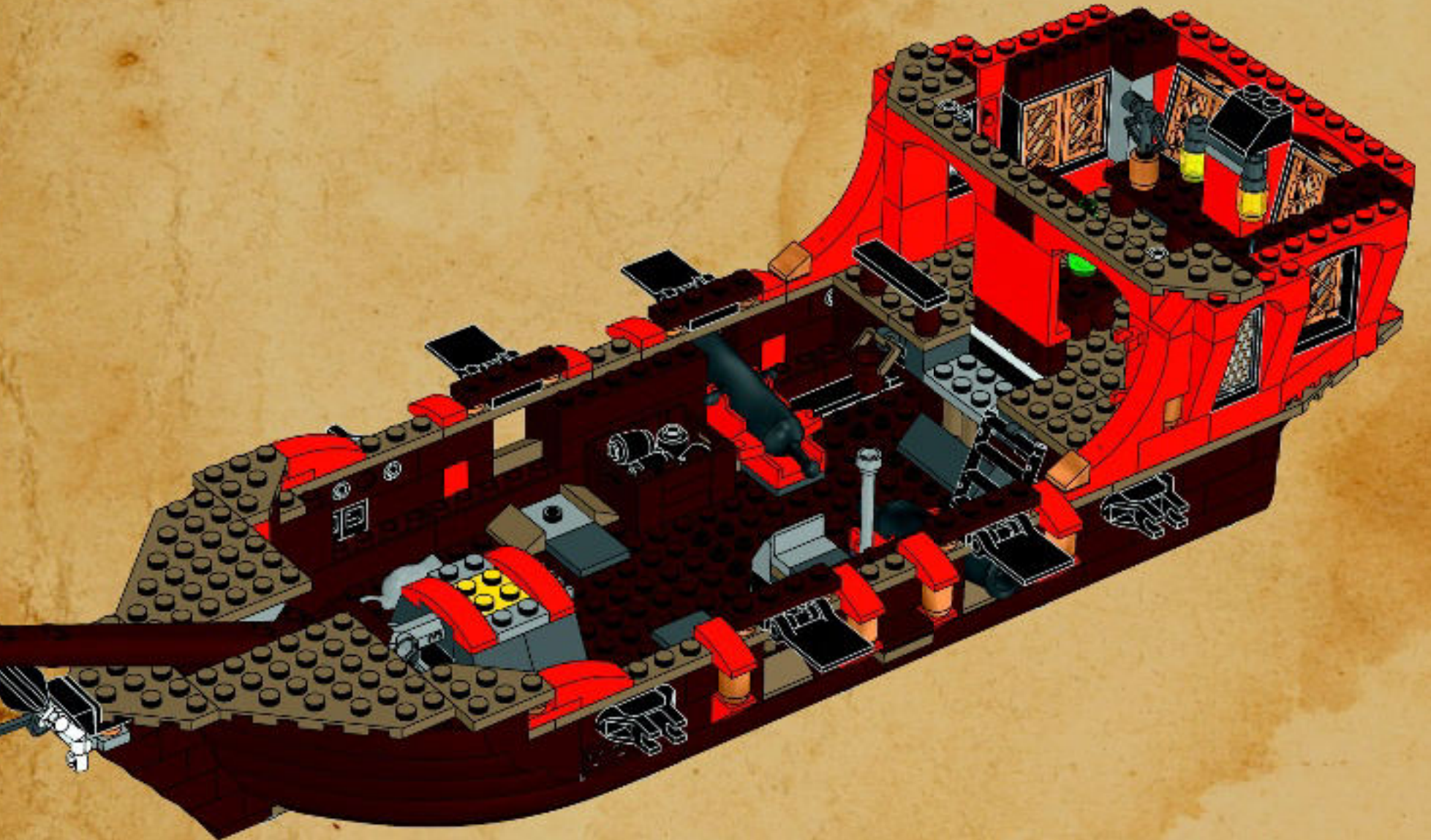



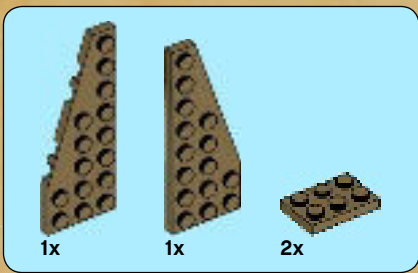

87

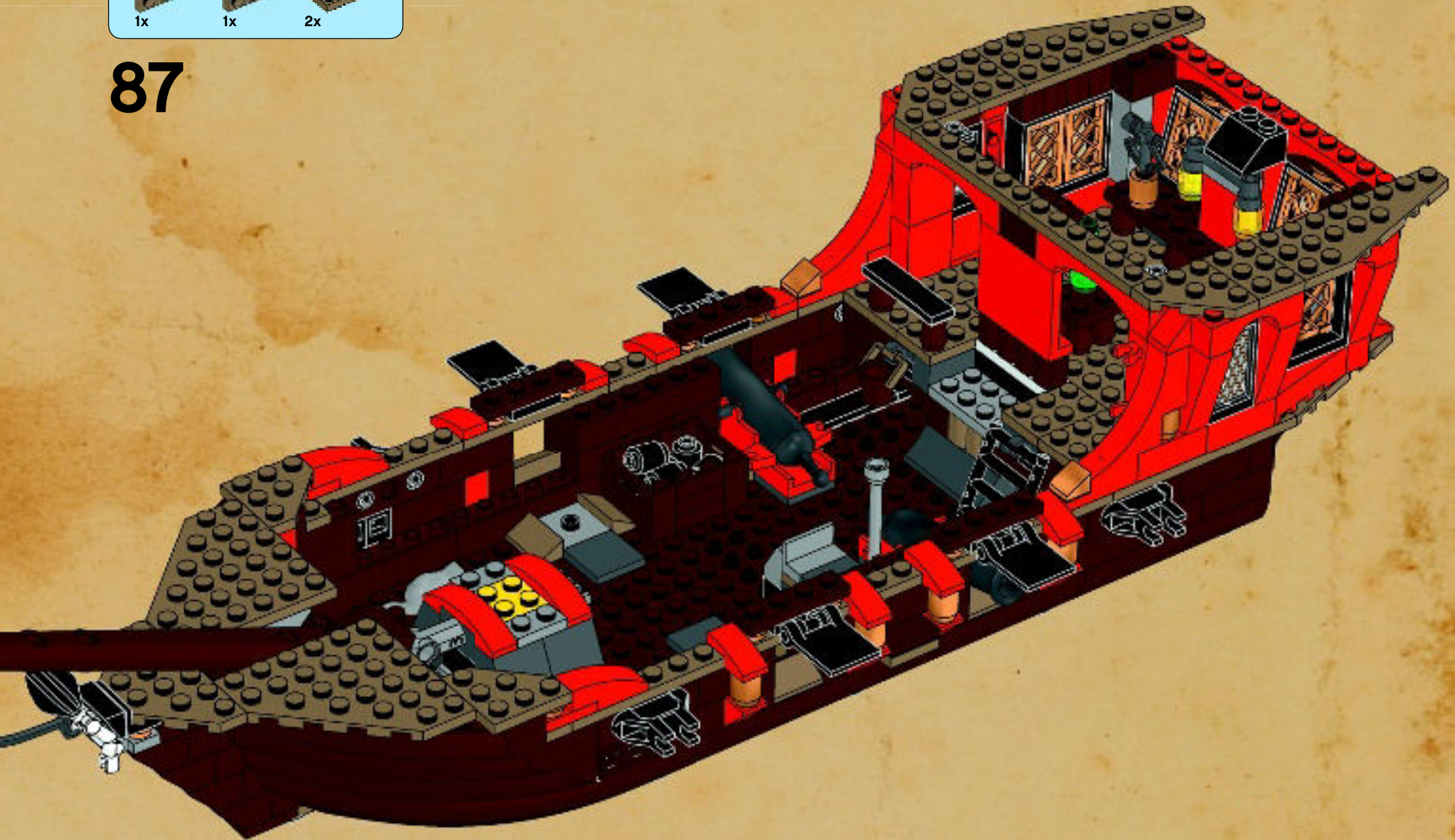





2x

88

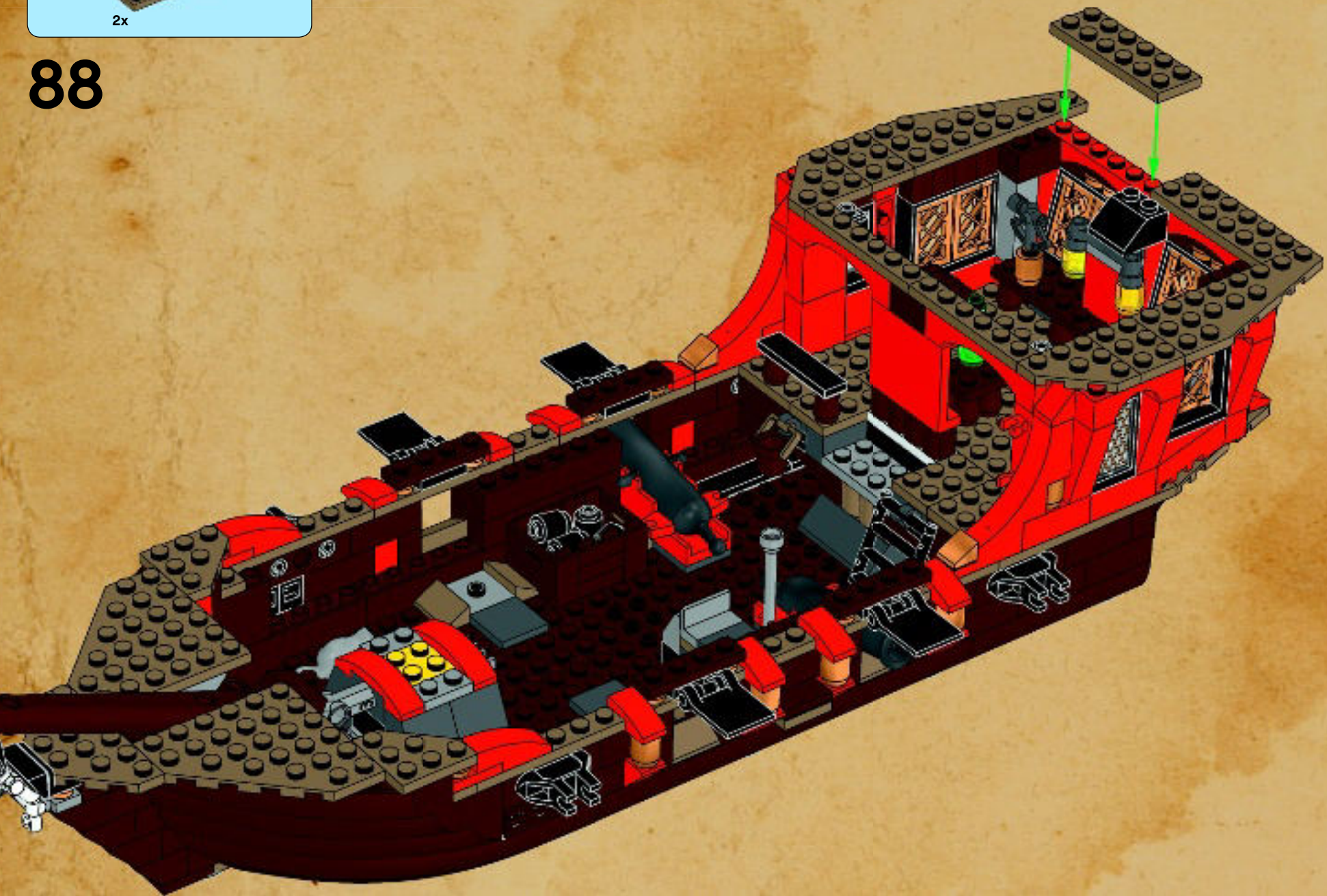





4x



2x

# 89

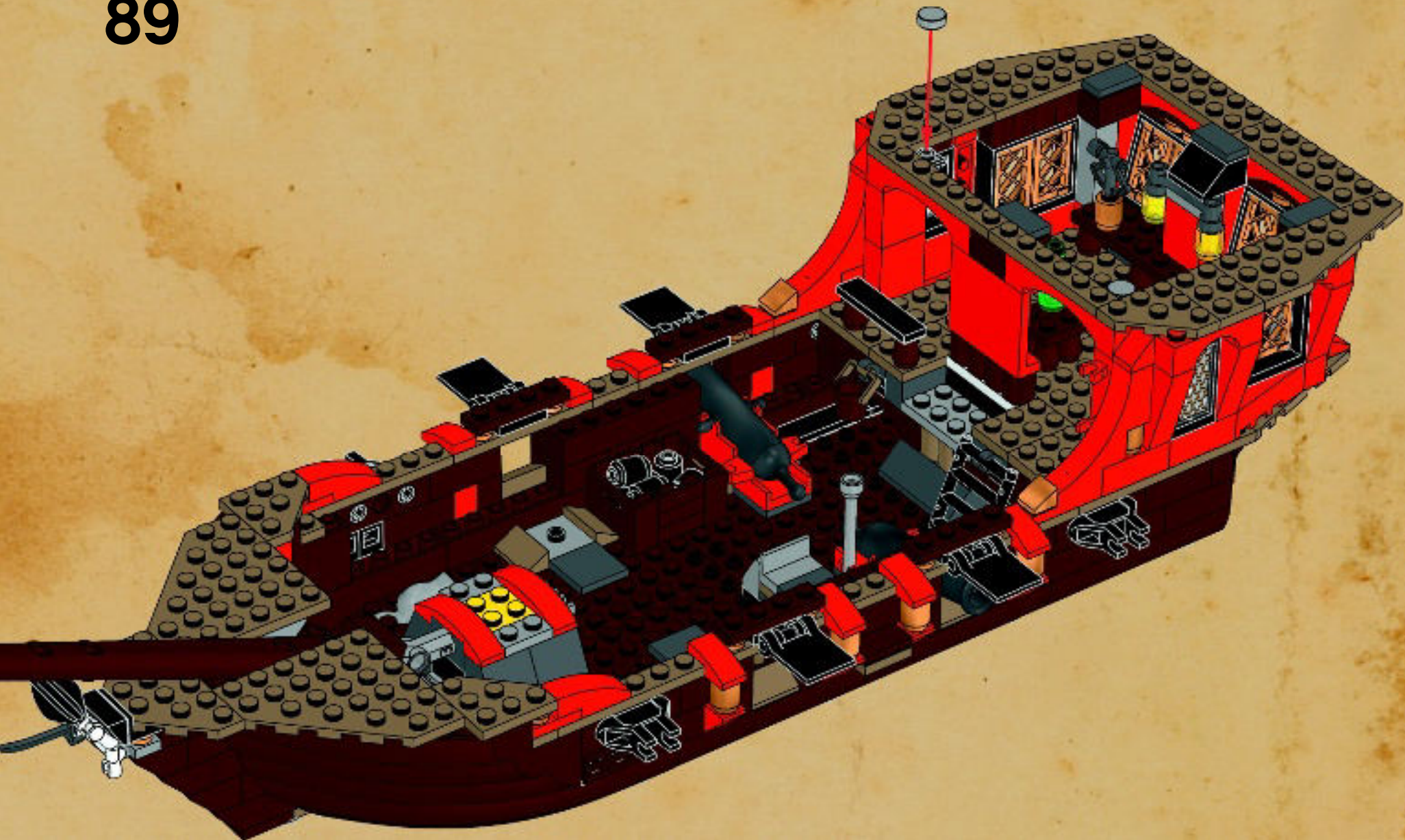



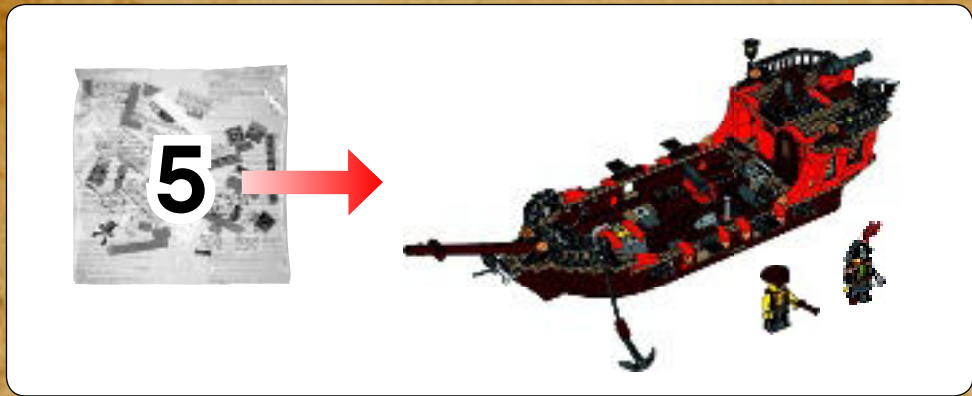





2x



1x

# 90

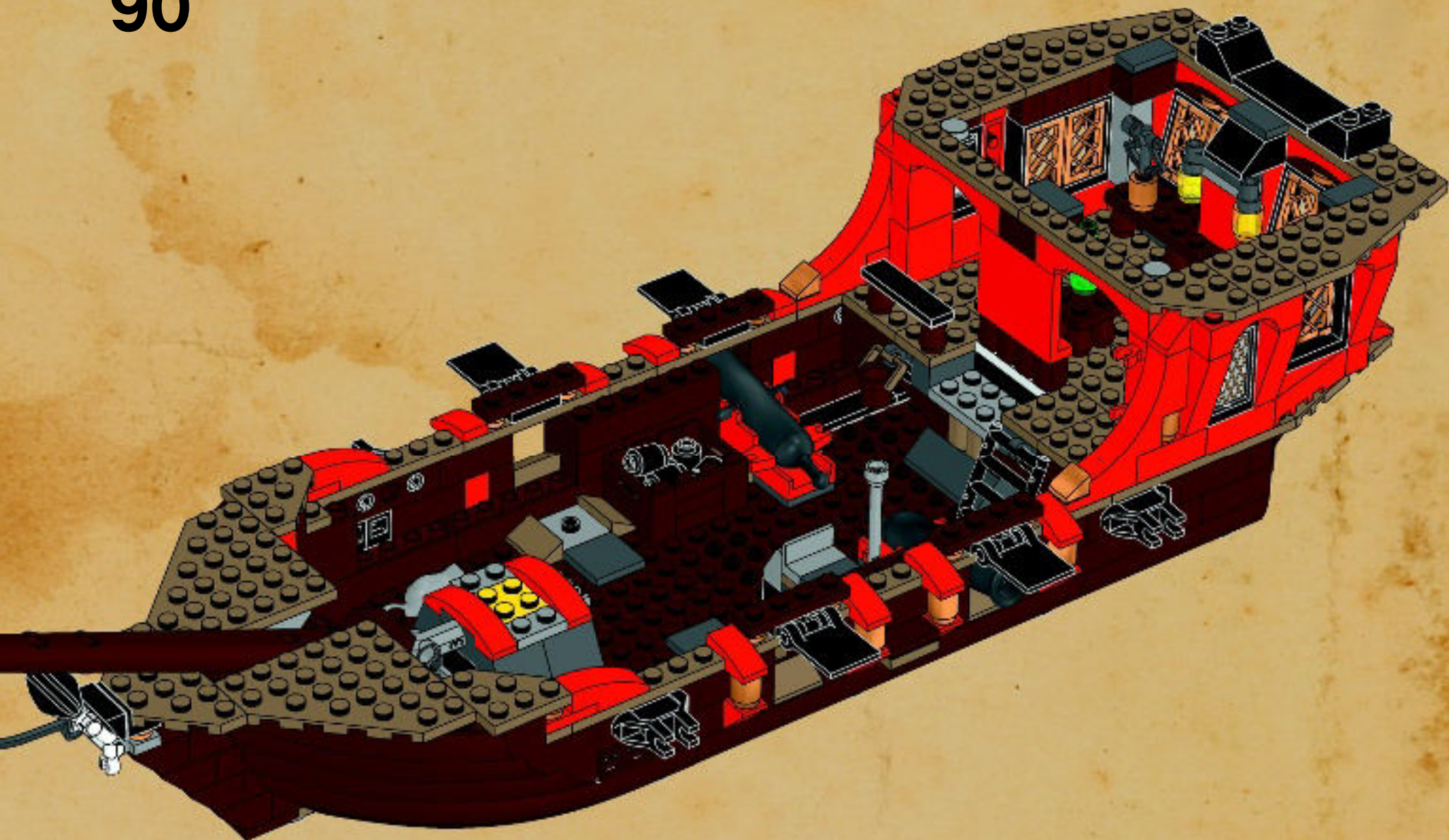





2x



2x

# 91

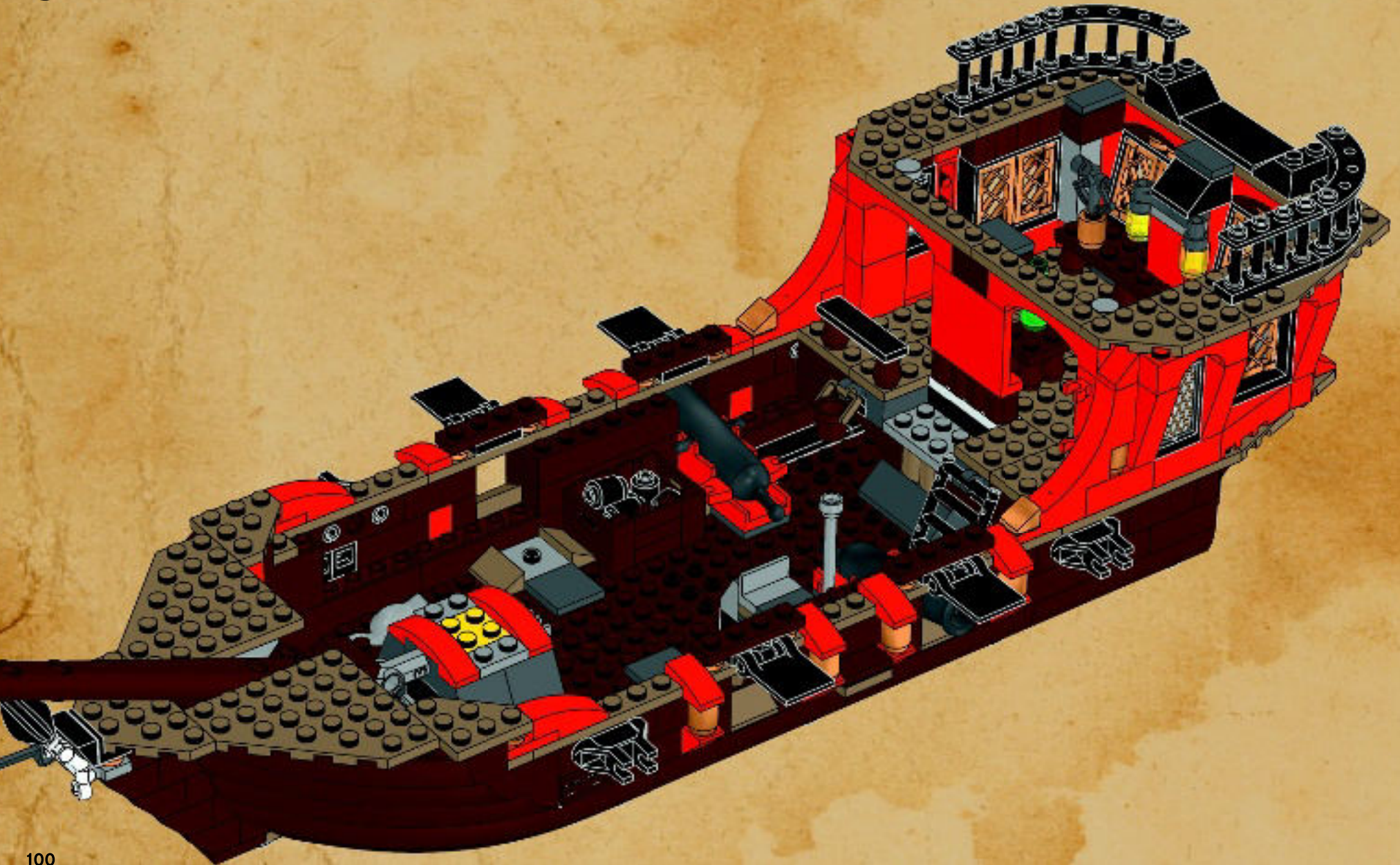







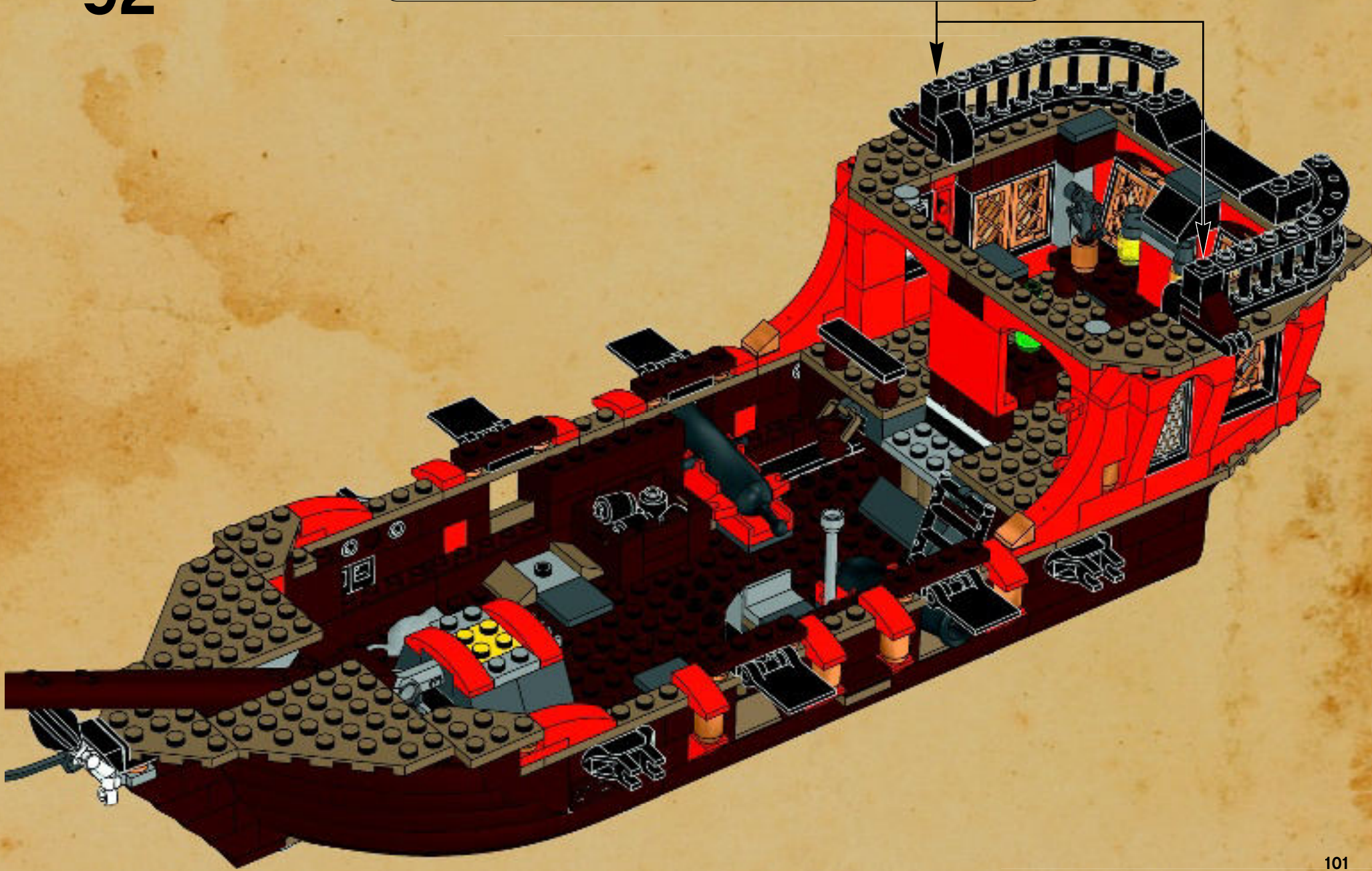



92





2x  2x  4x 

93

   2x

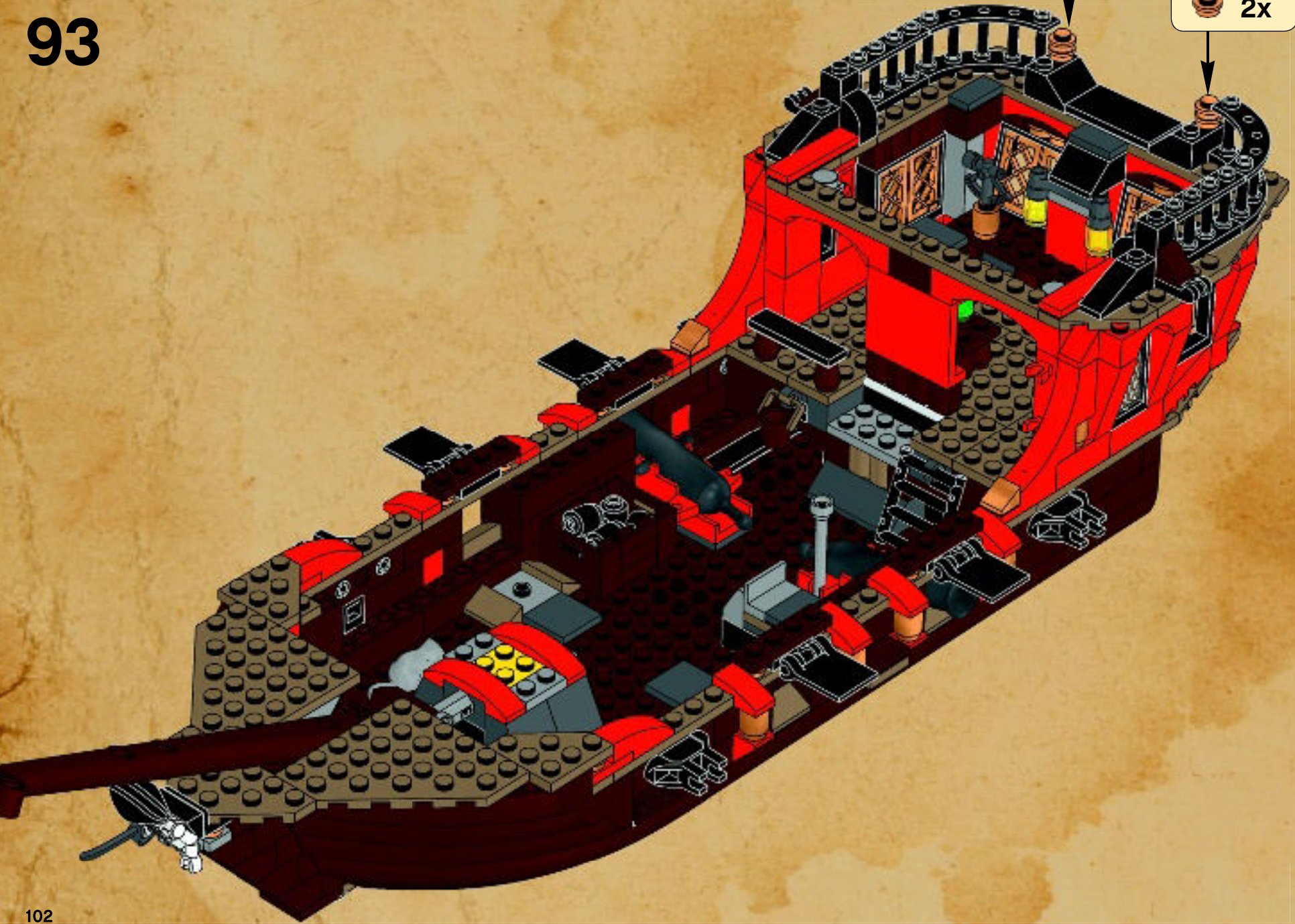





94

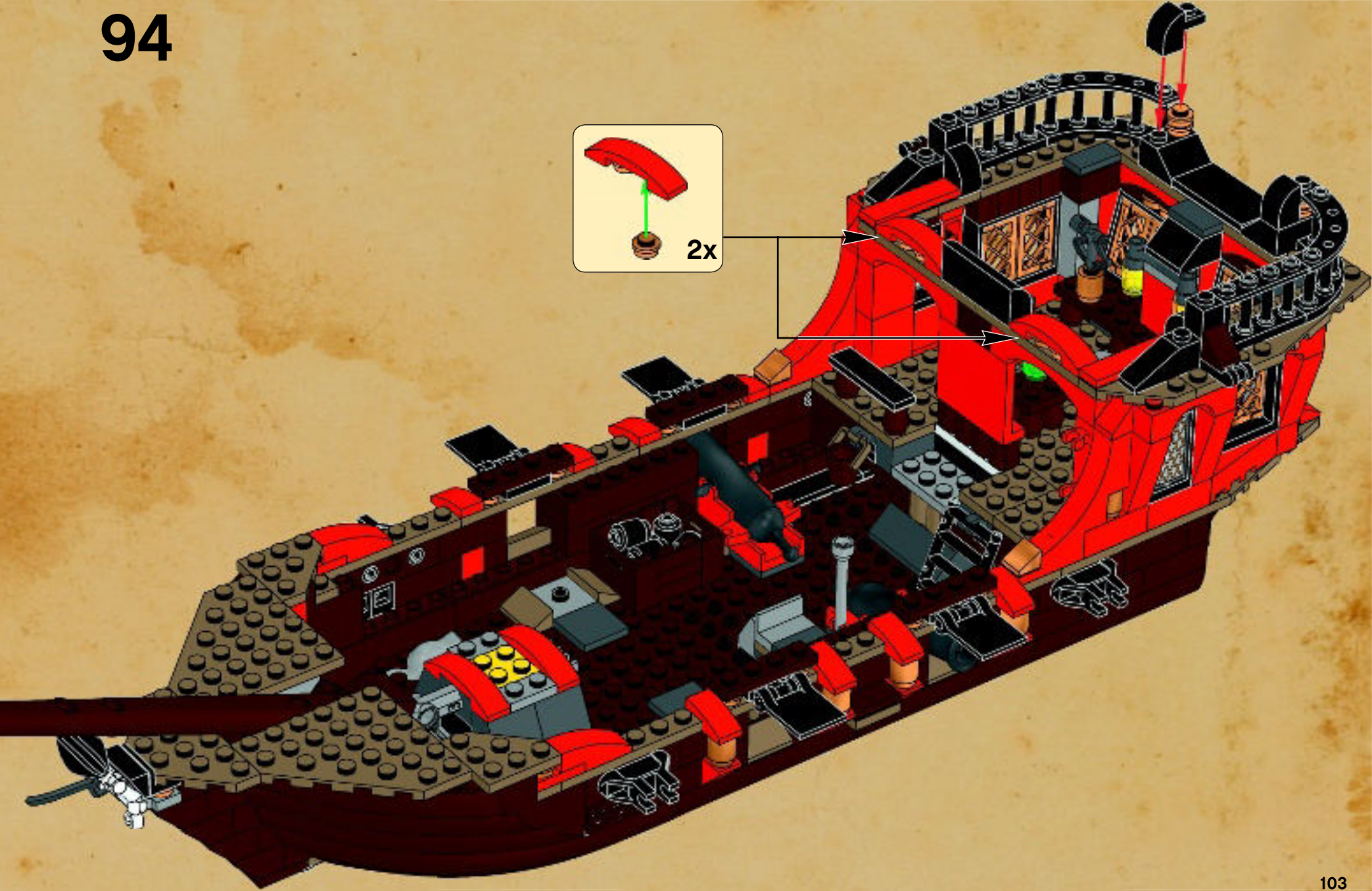
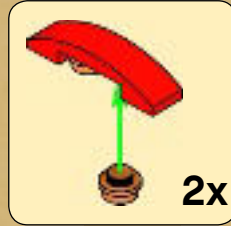



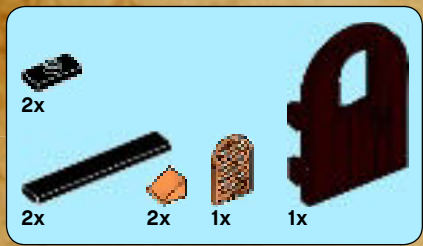

95

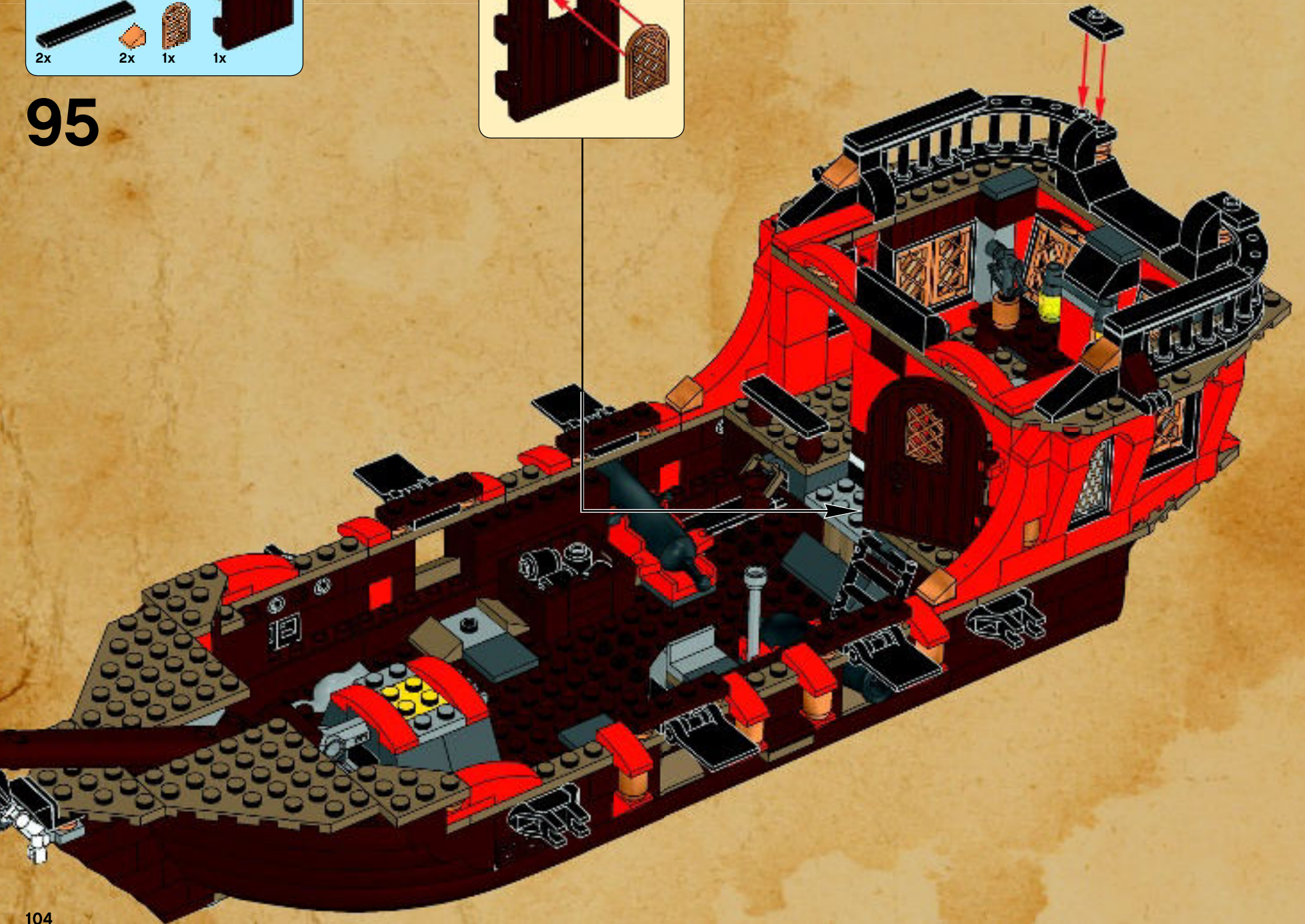





96

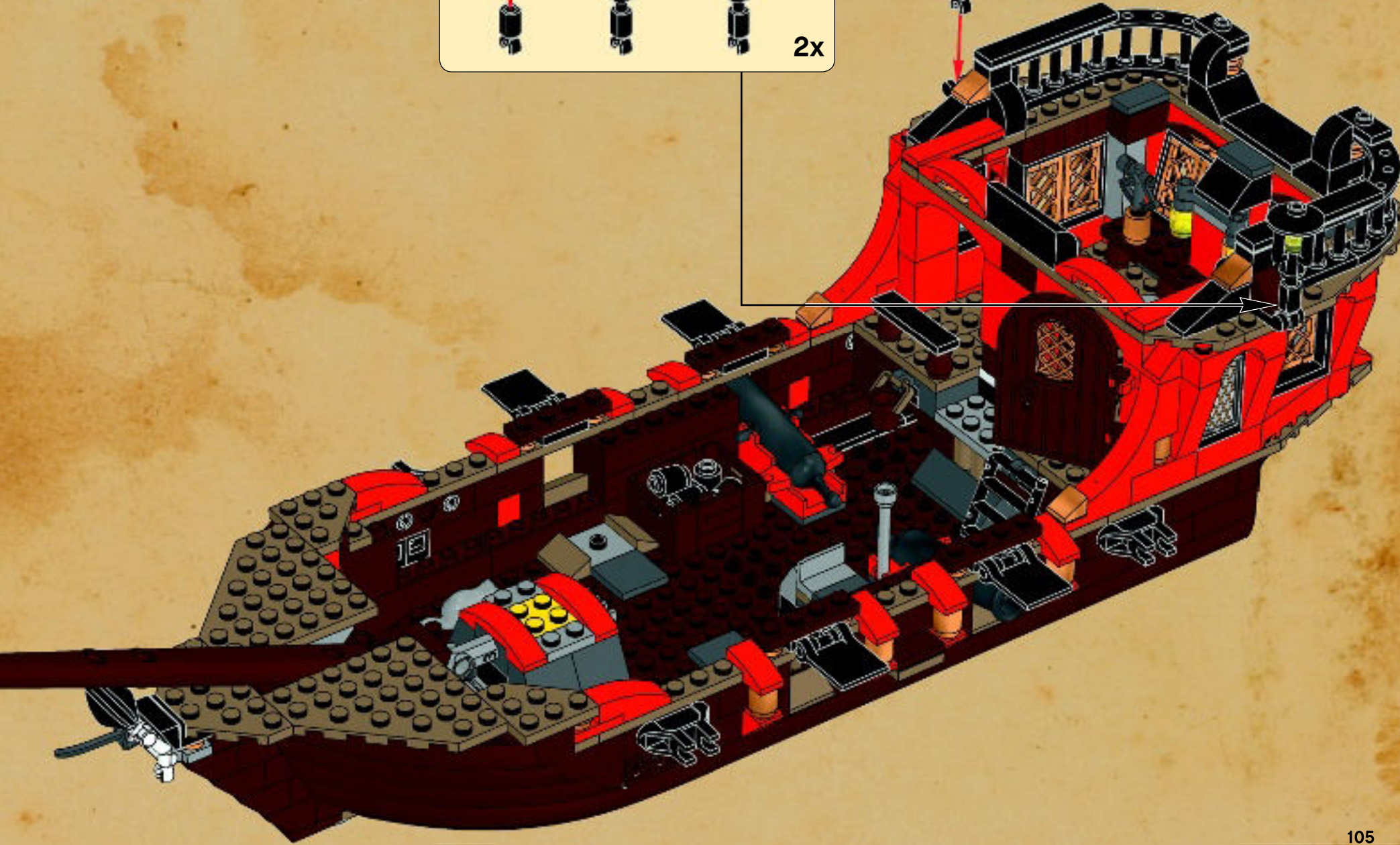
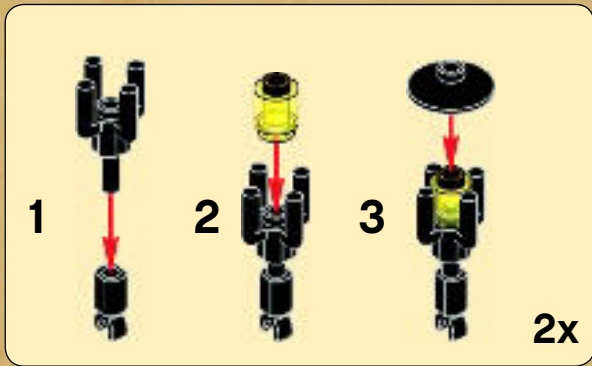



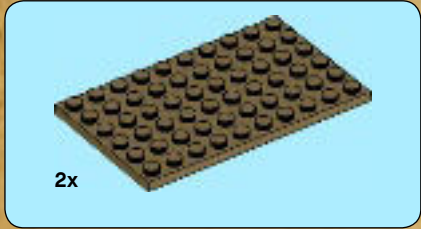

1

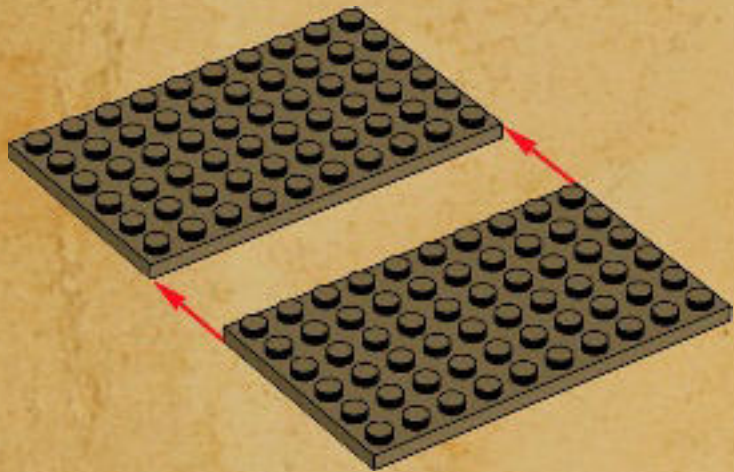

2

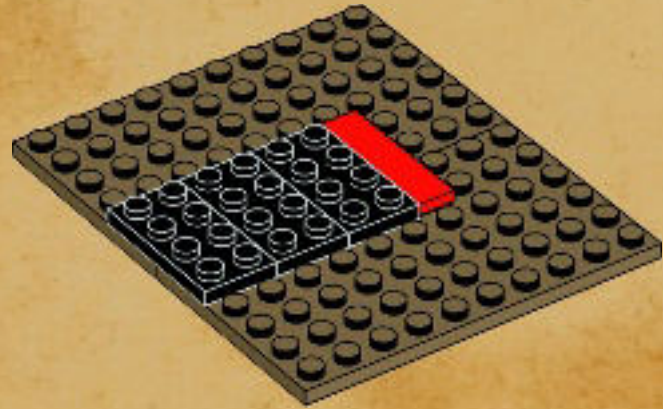

3

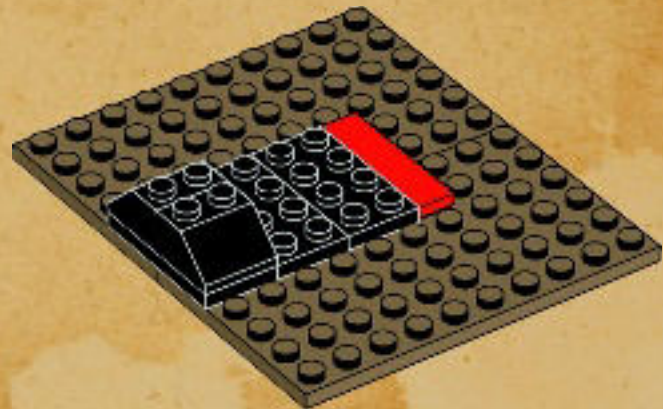



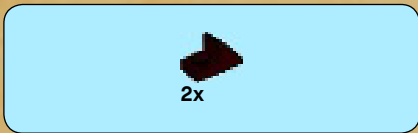

4

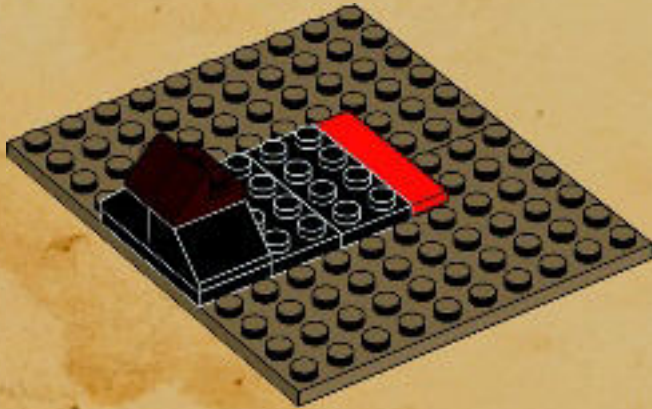

5

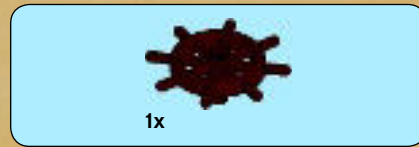
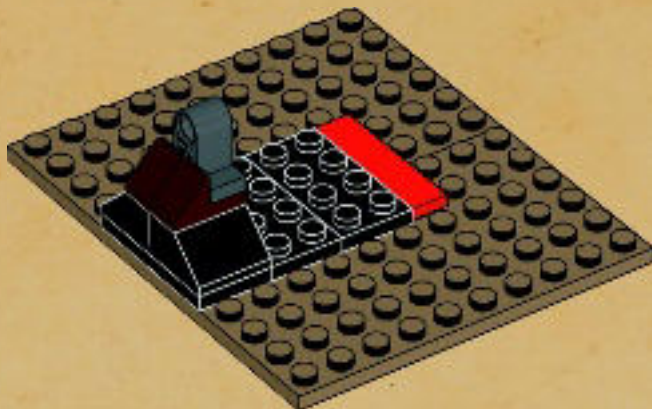

6

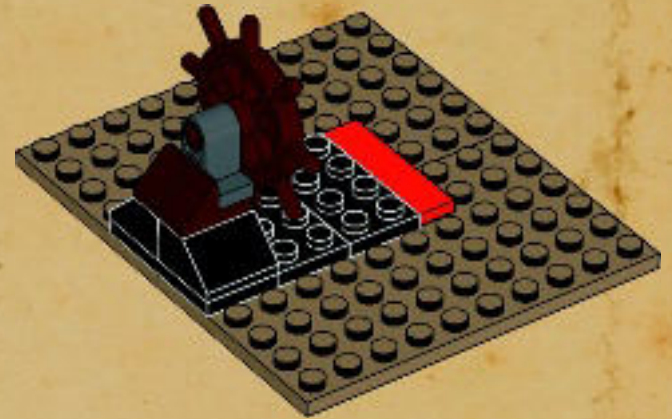



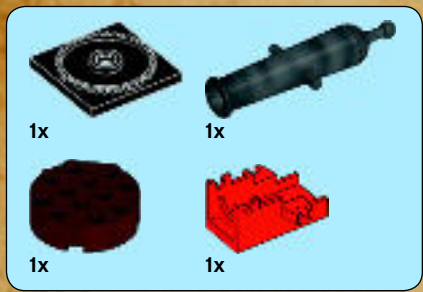

7

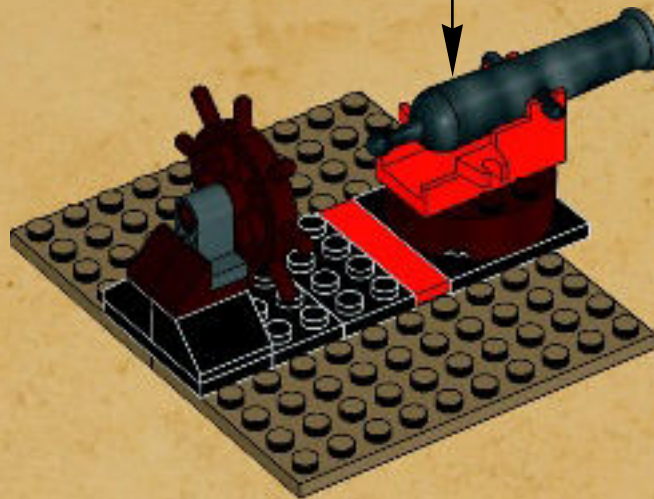
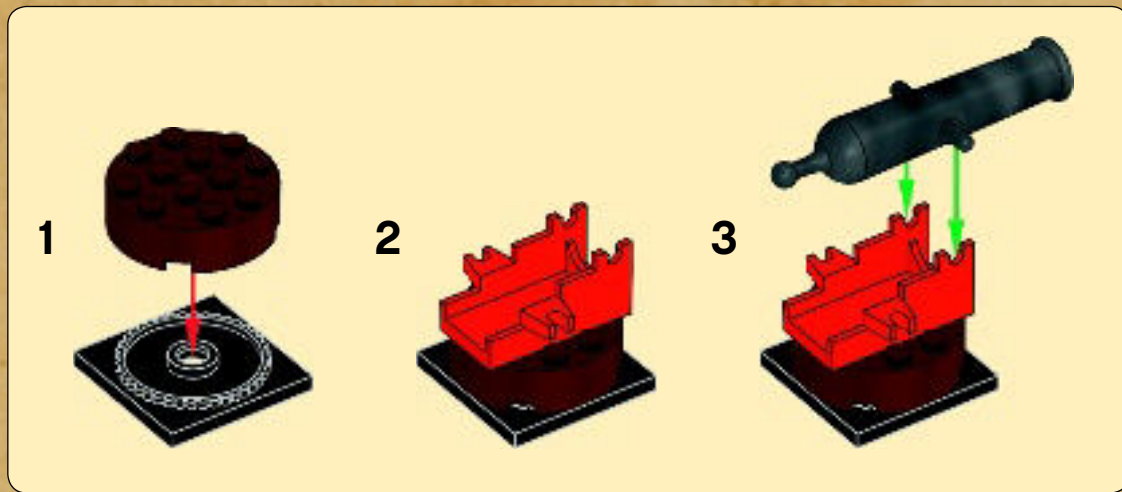



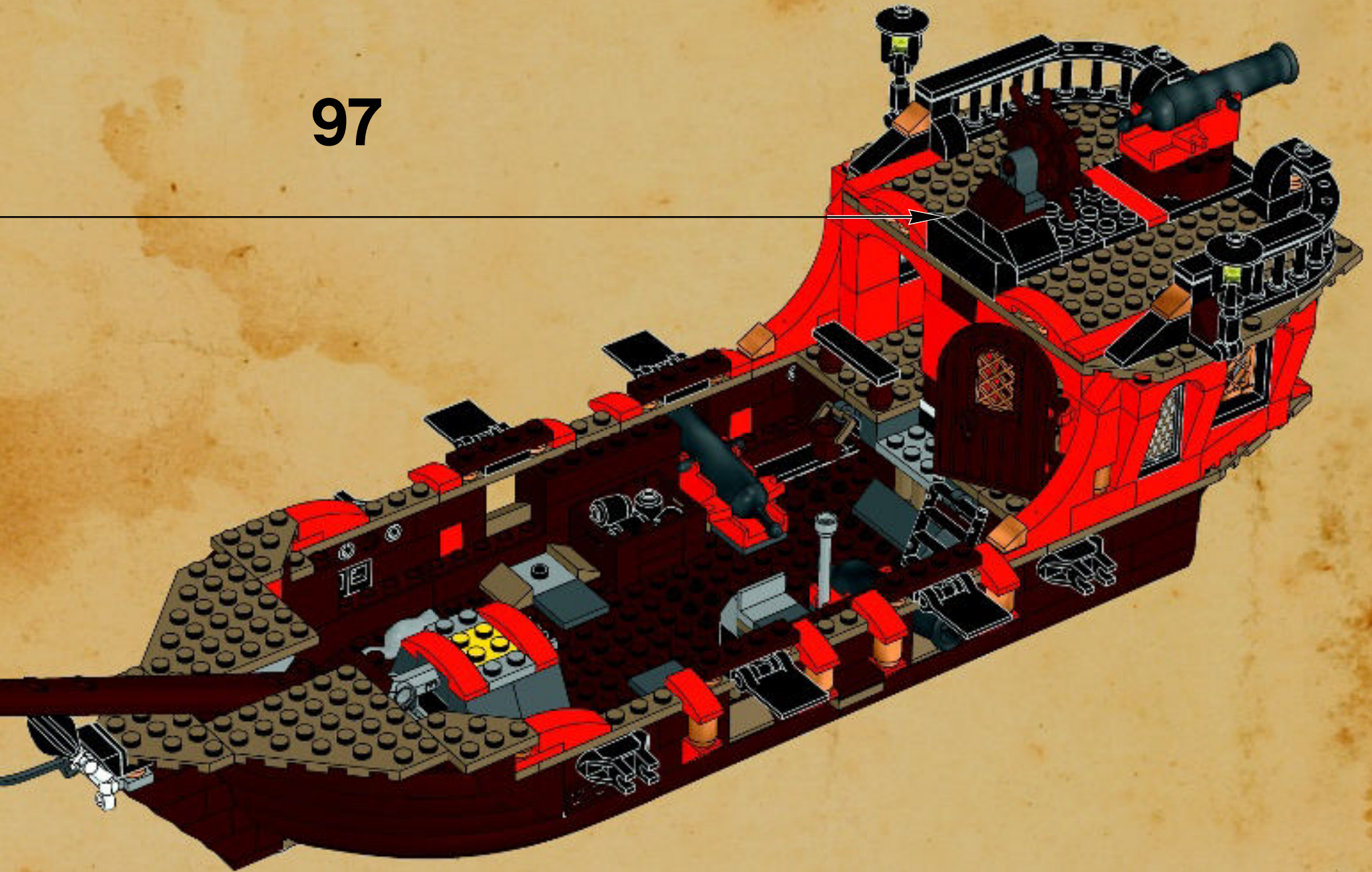

97





4x  1x 

98

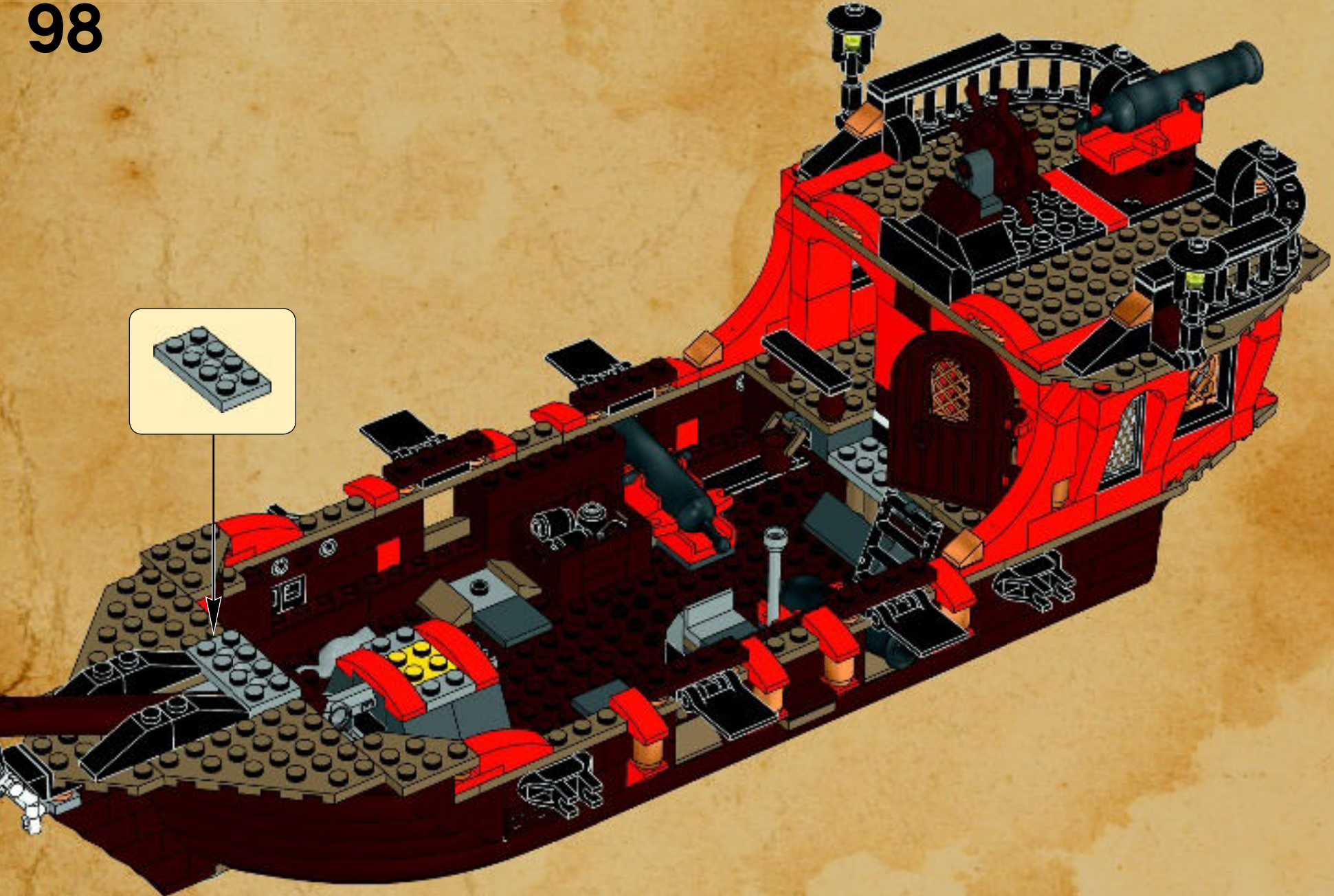





99

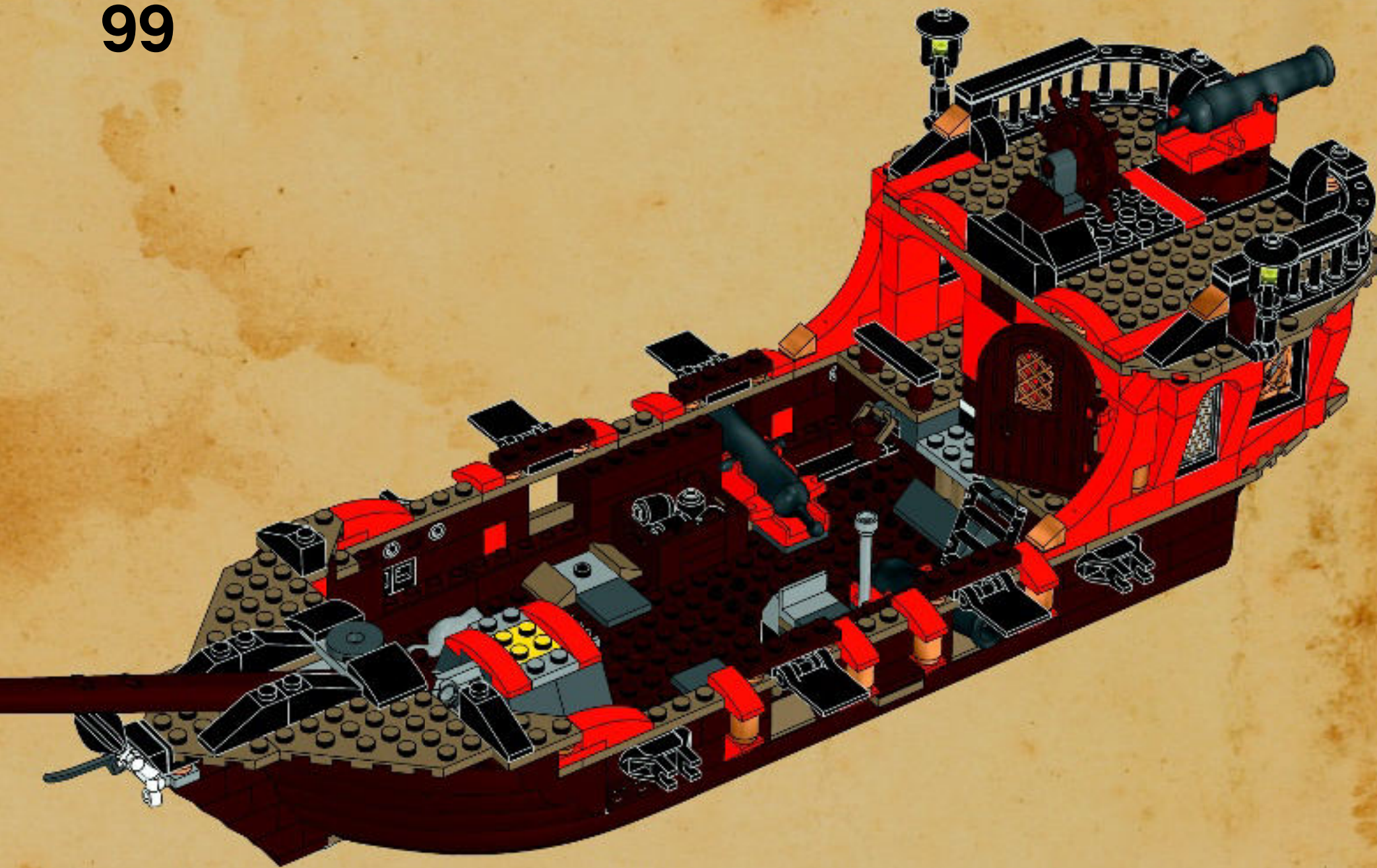





2x



1x



2x



2x

# 100

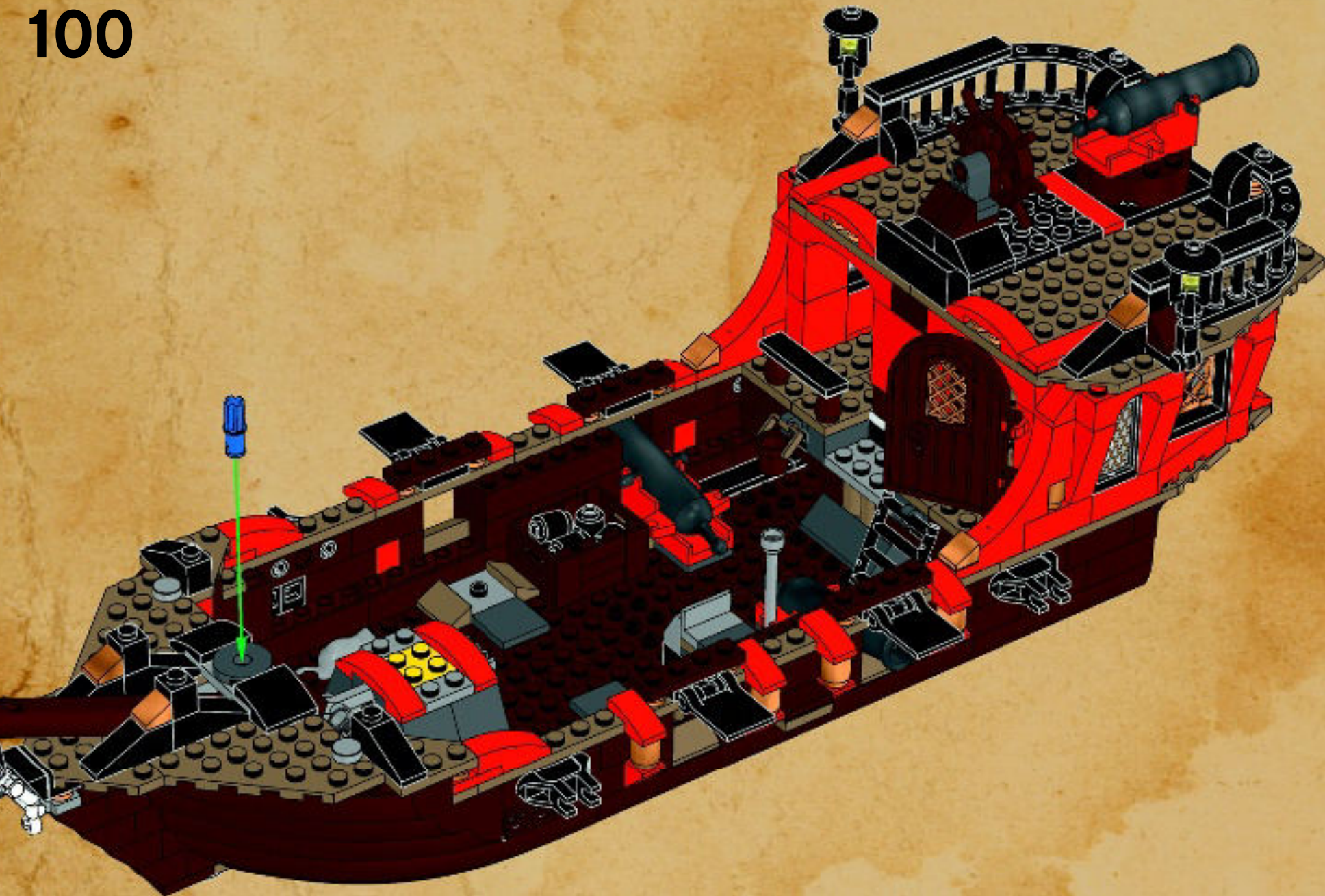





2x

101

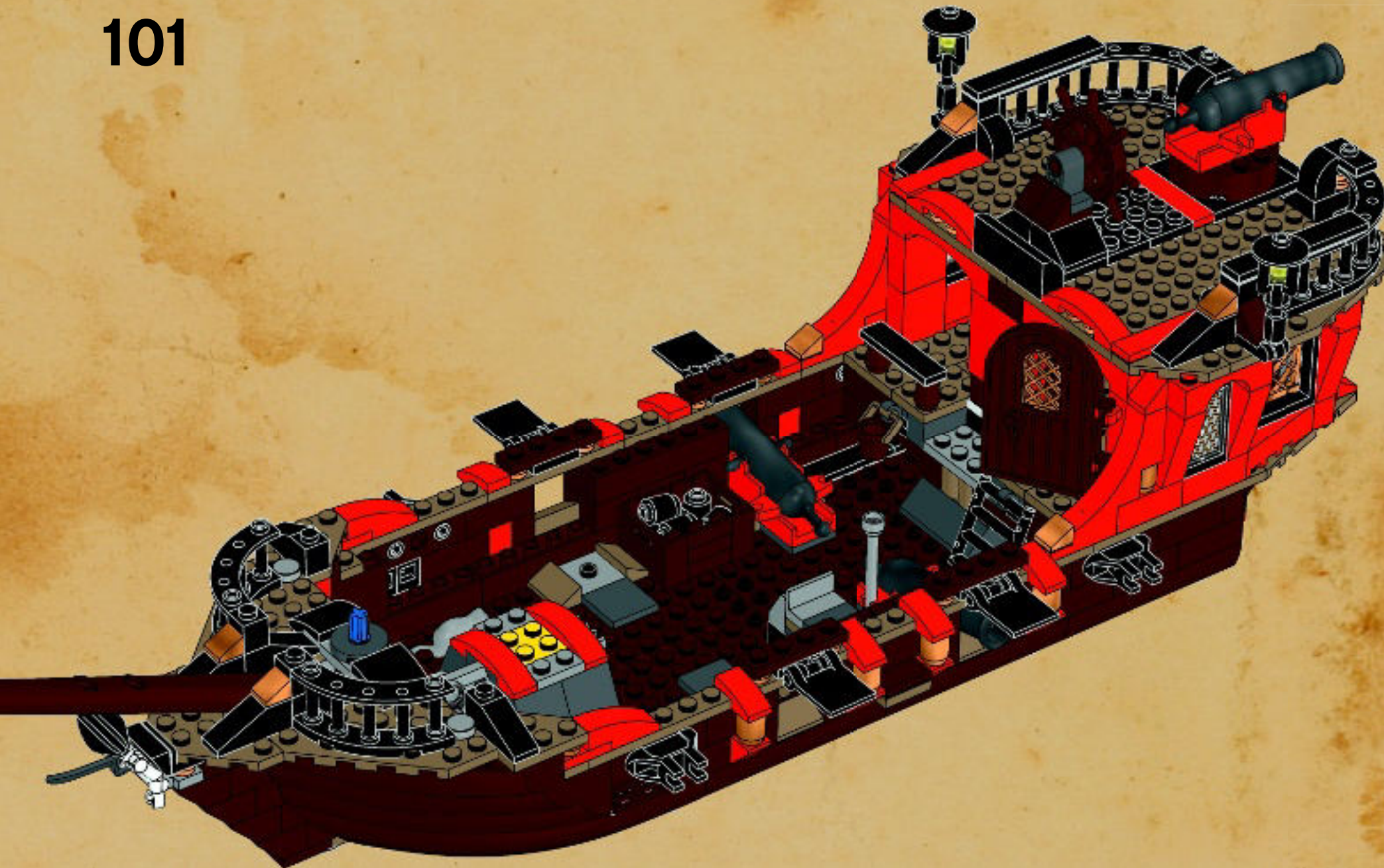



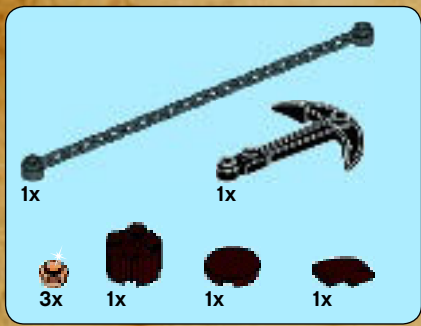

102

1



2



3



4





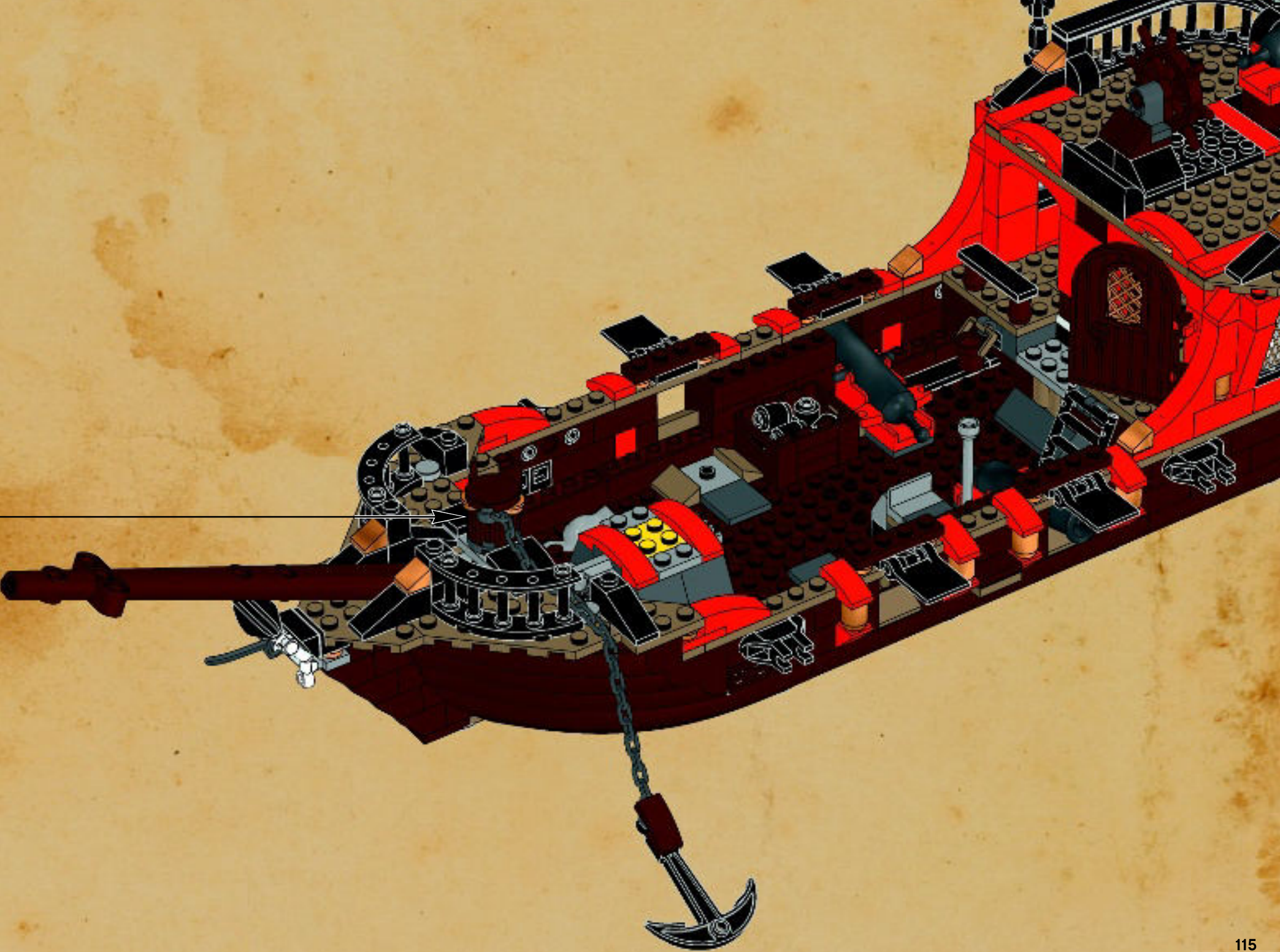





2x

# 103



2x

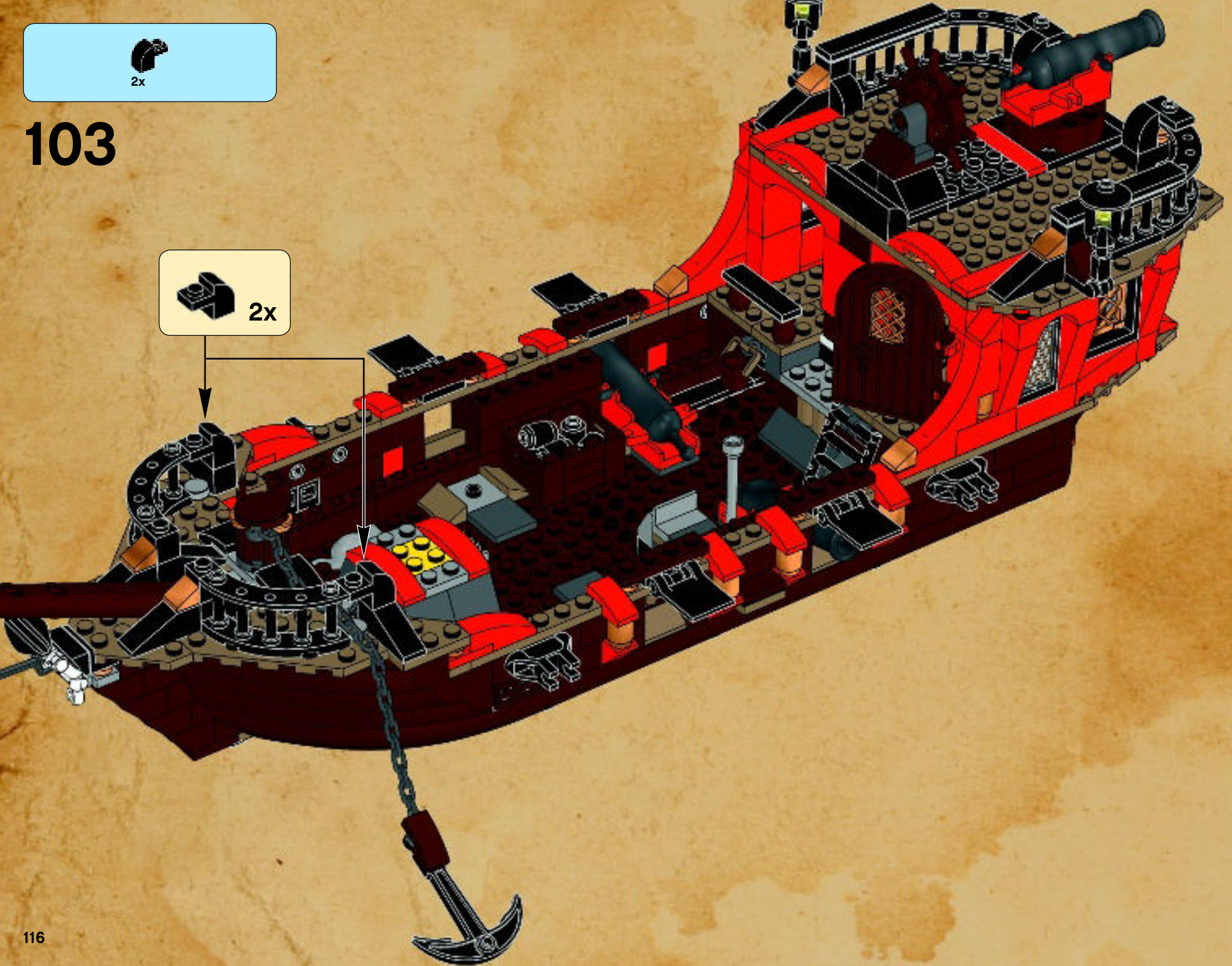





4x

# 104

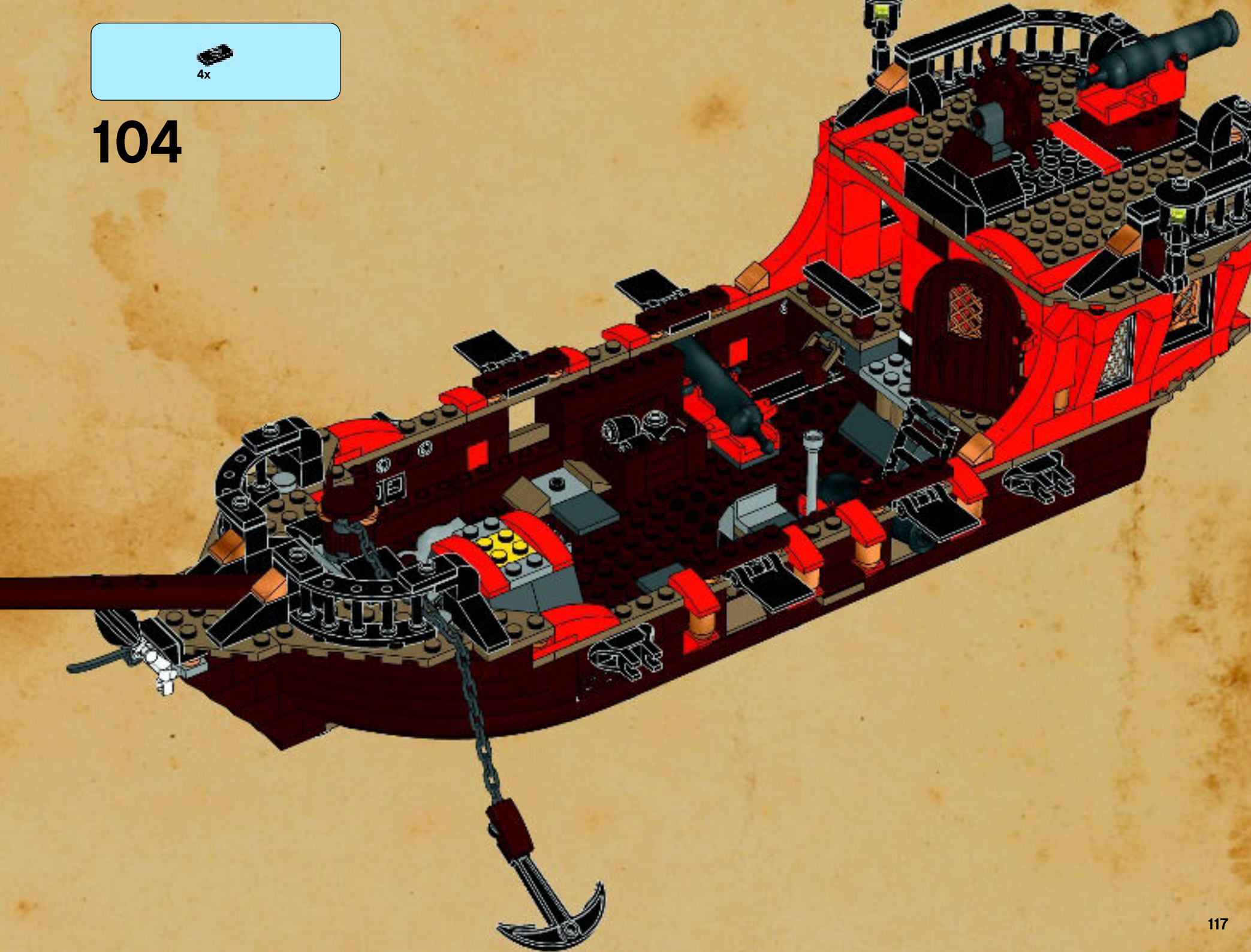



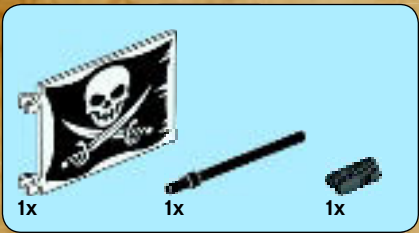

105

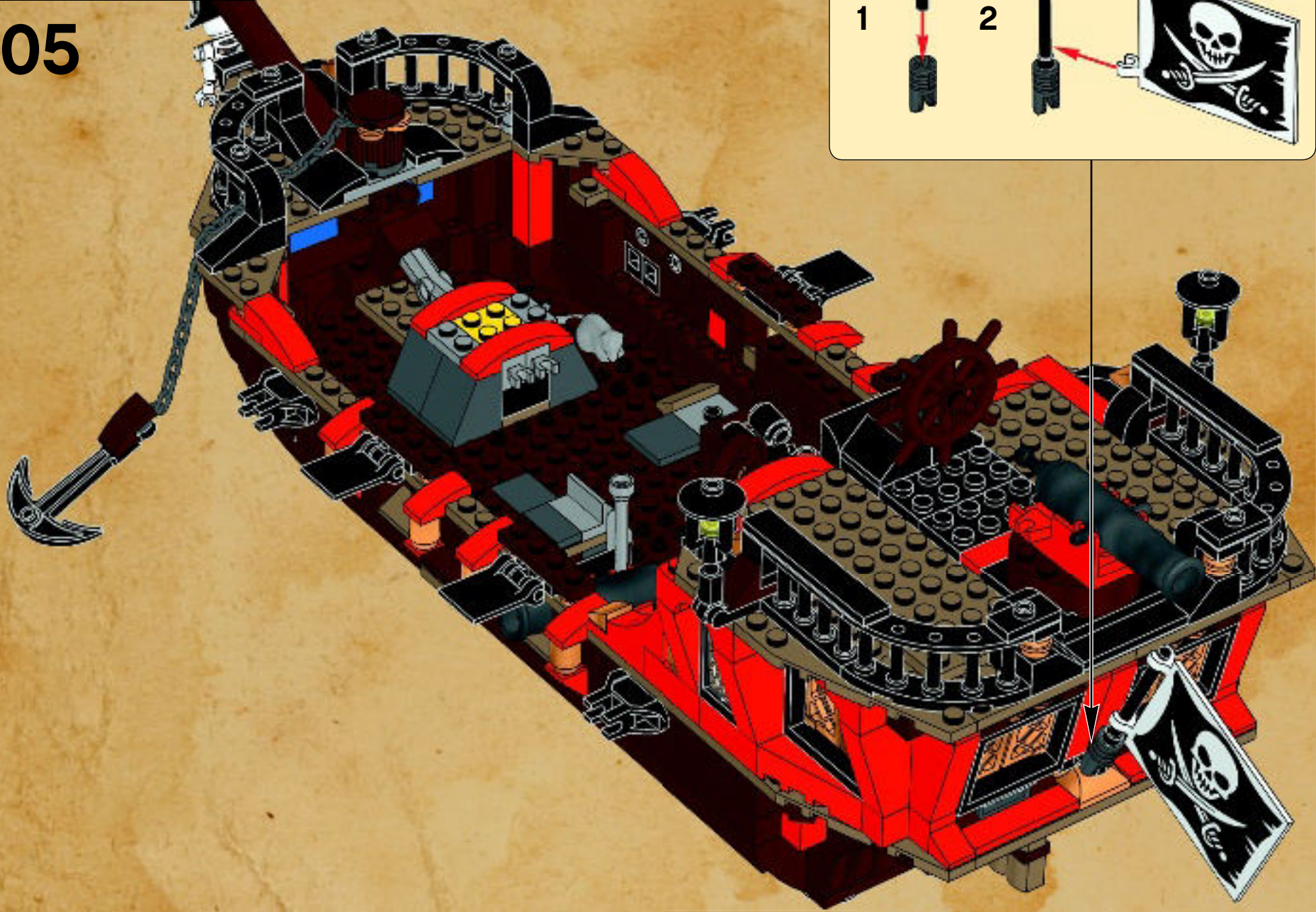
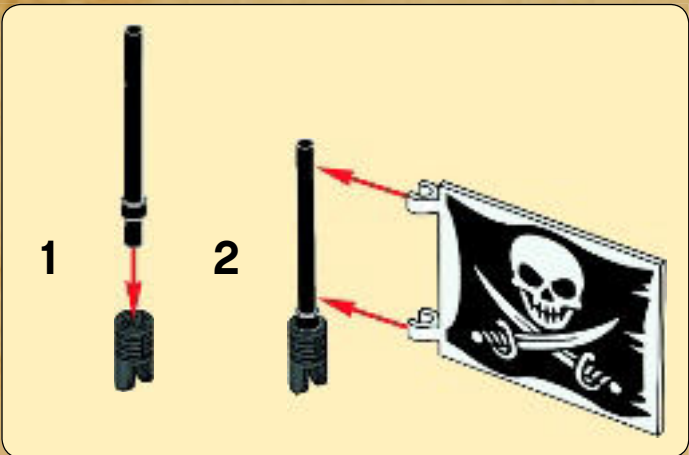



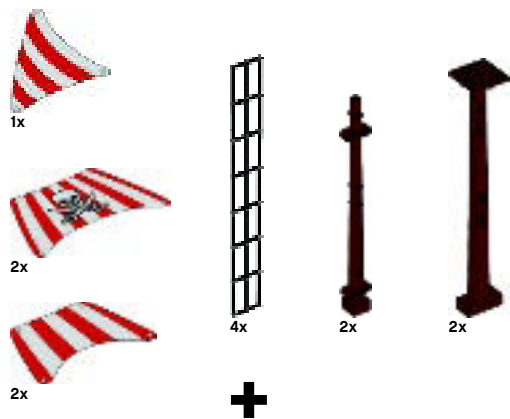



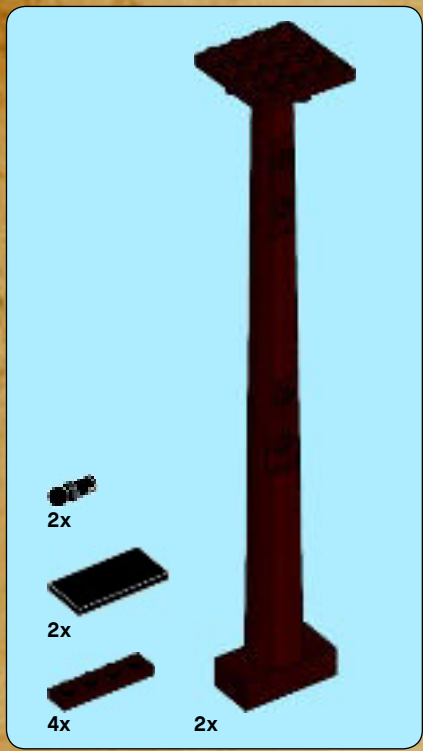

106

1



2



2x



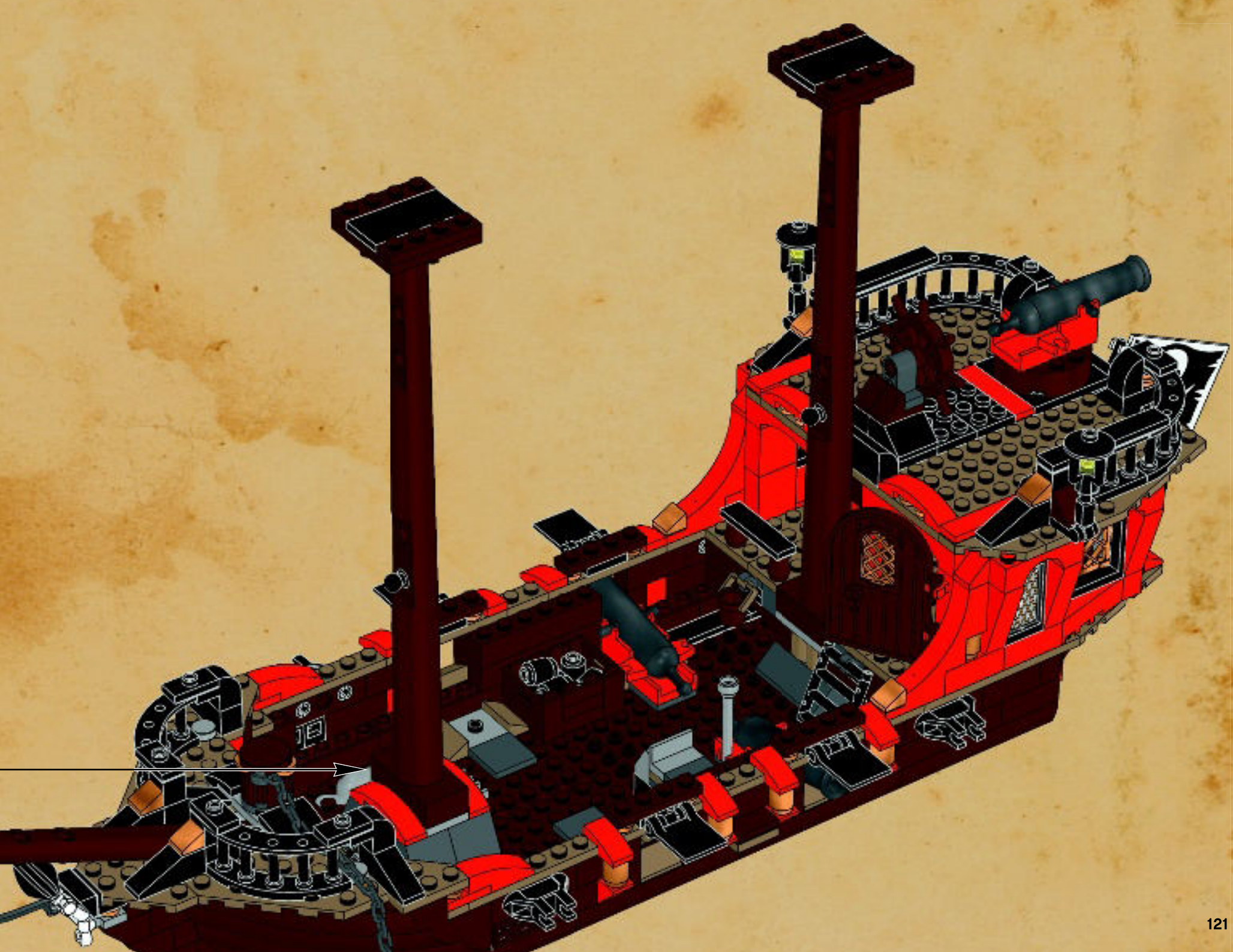





1



3

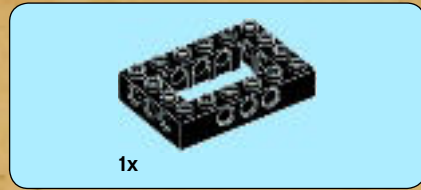
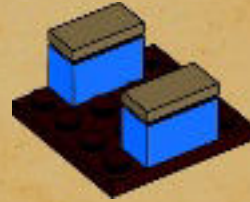

2







4

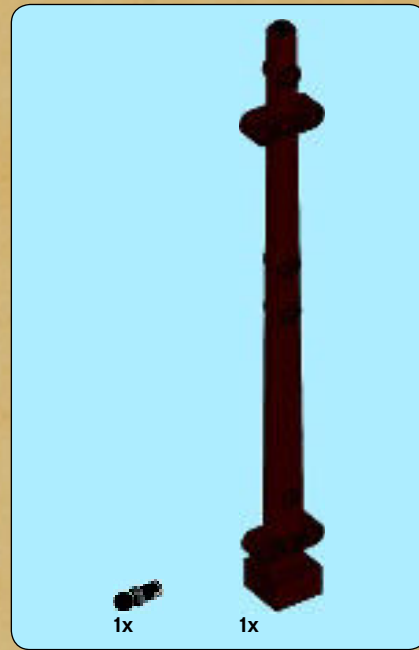
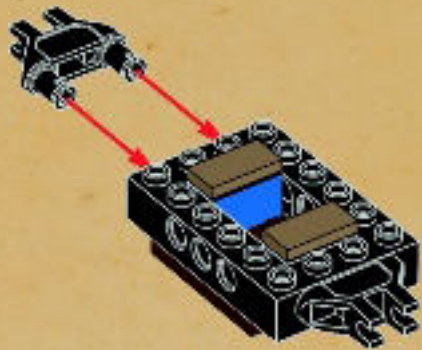

5

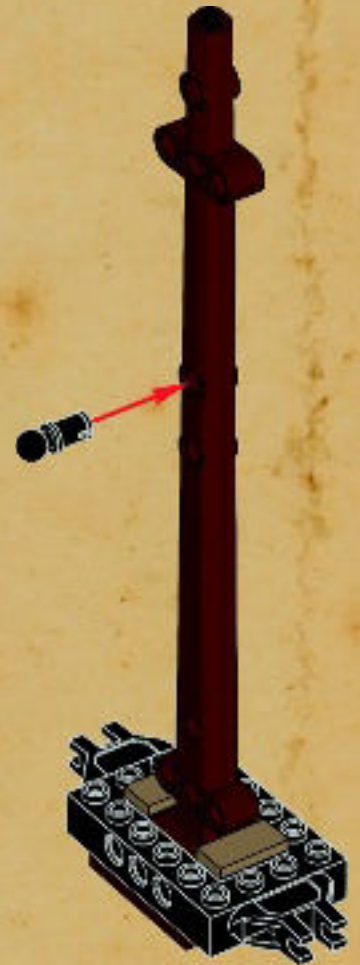





6



7







8



107

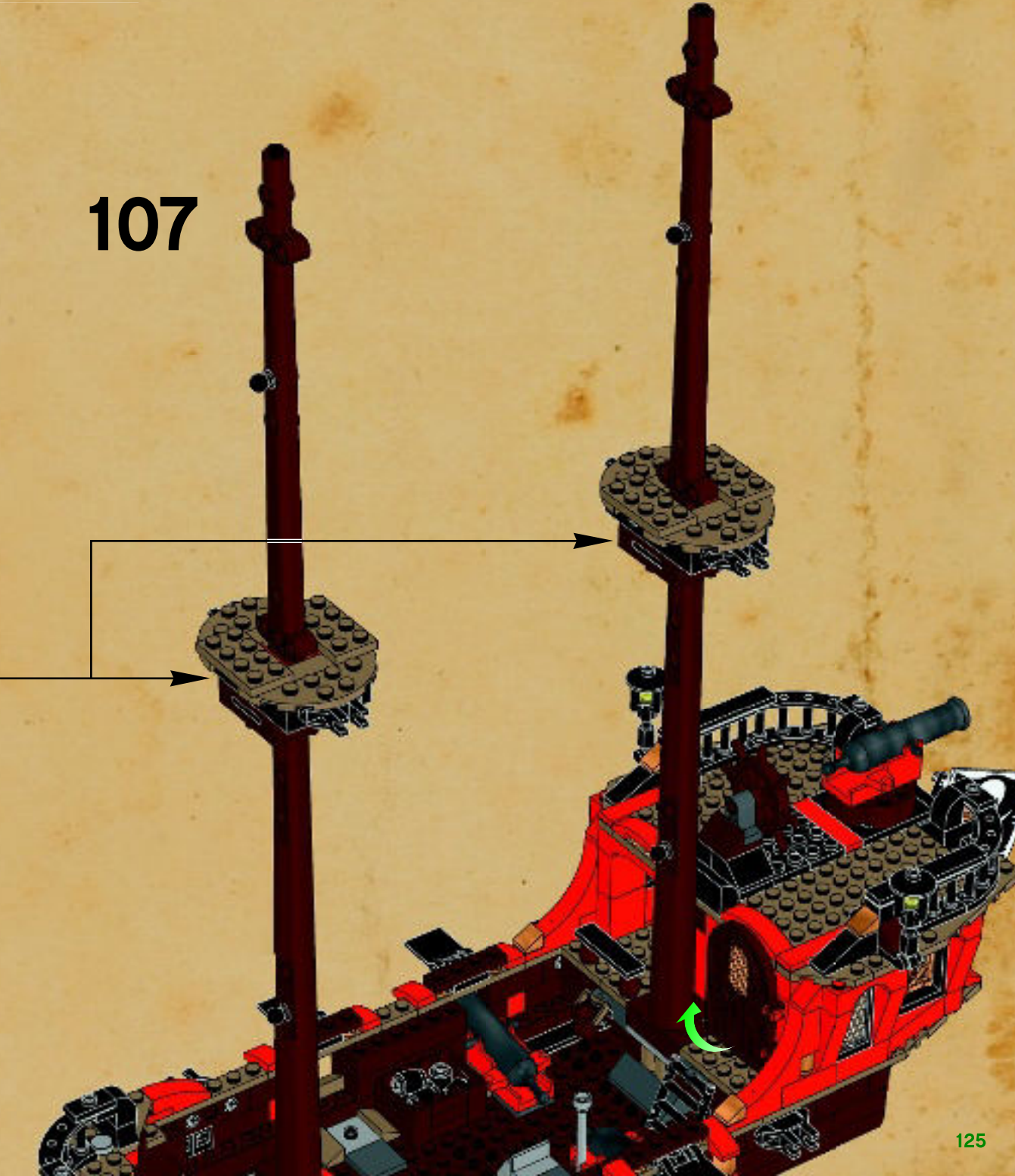



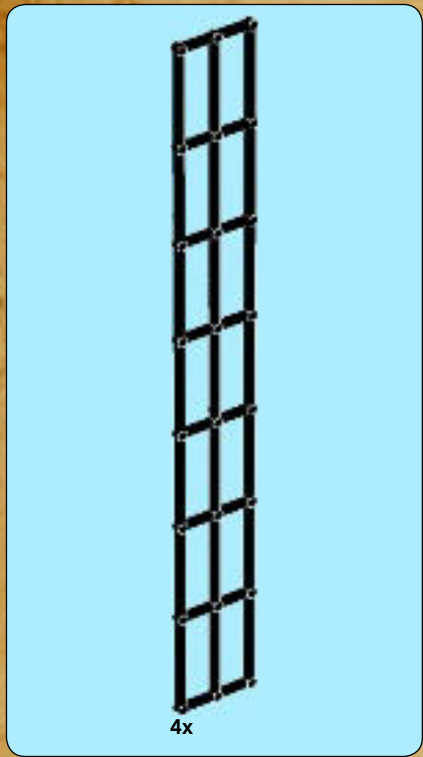

108

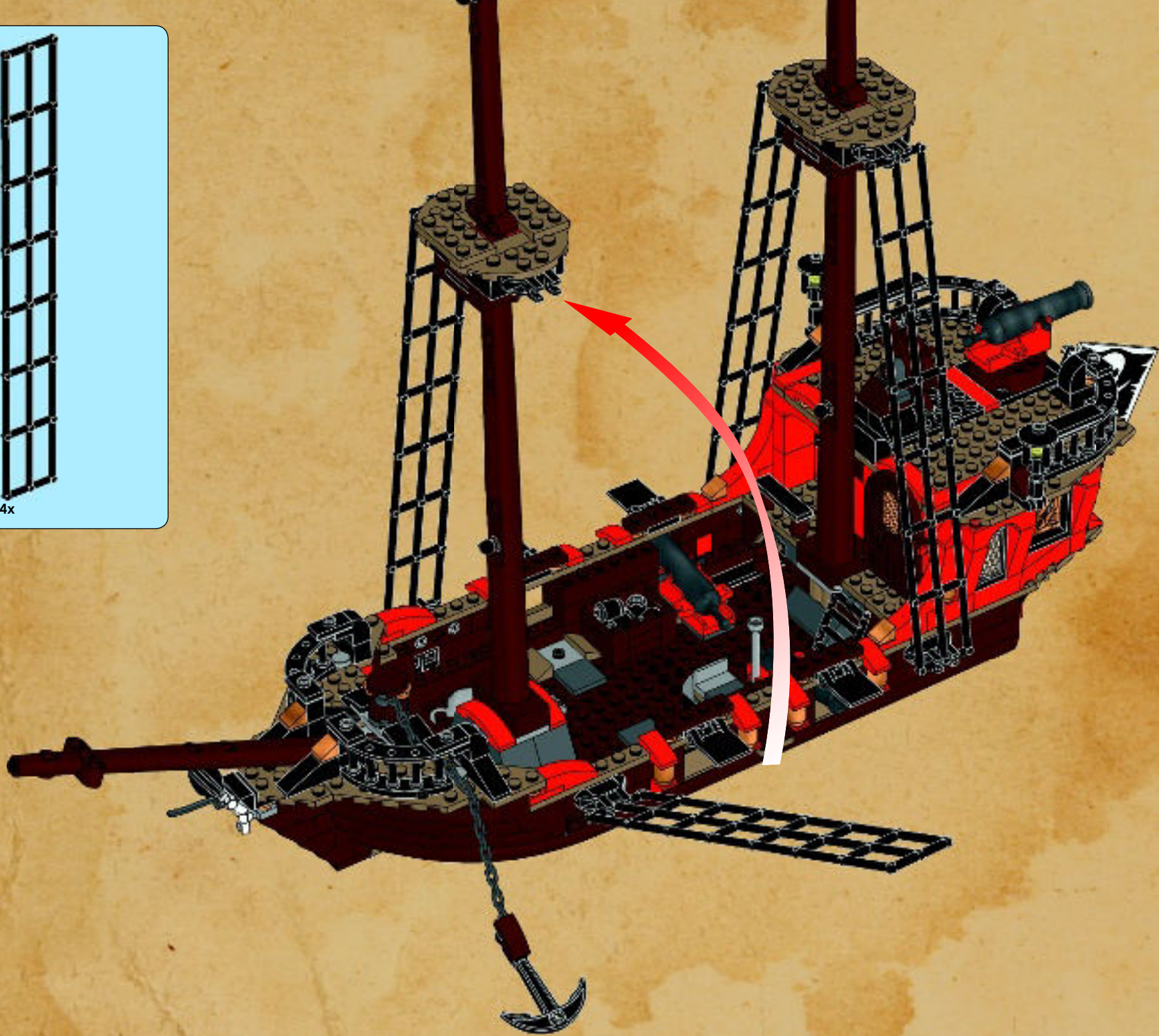



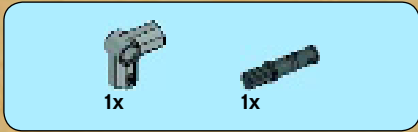

1

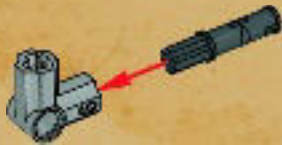

2

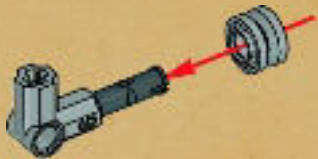

3

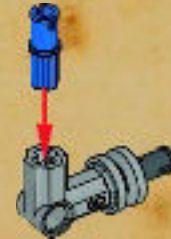



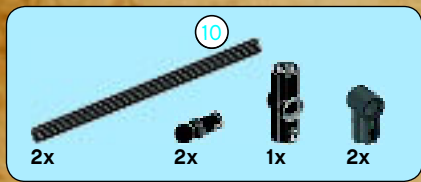

4

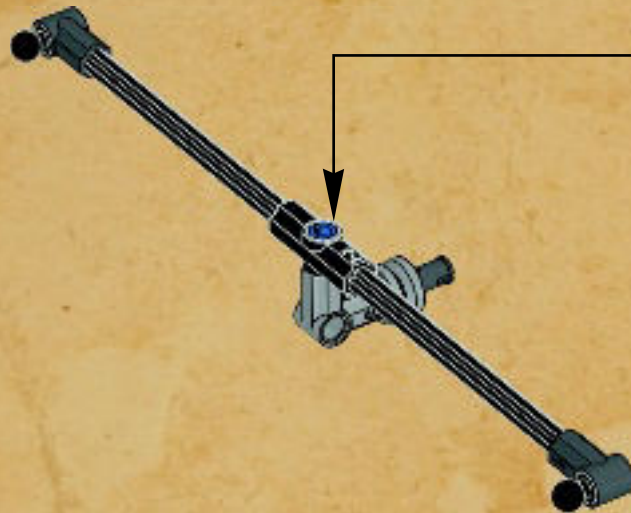
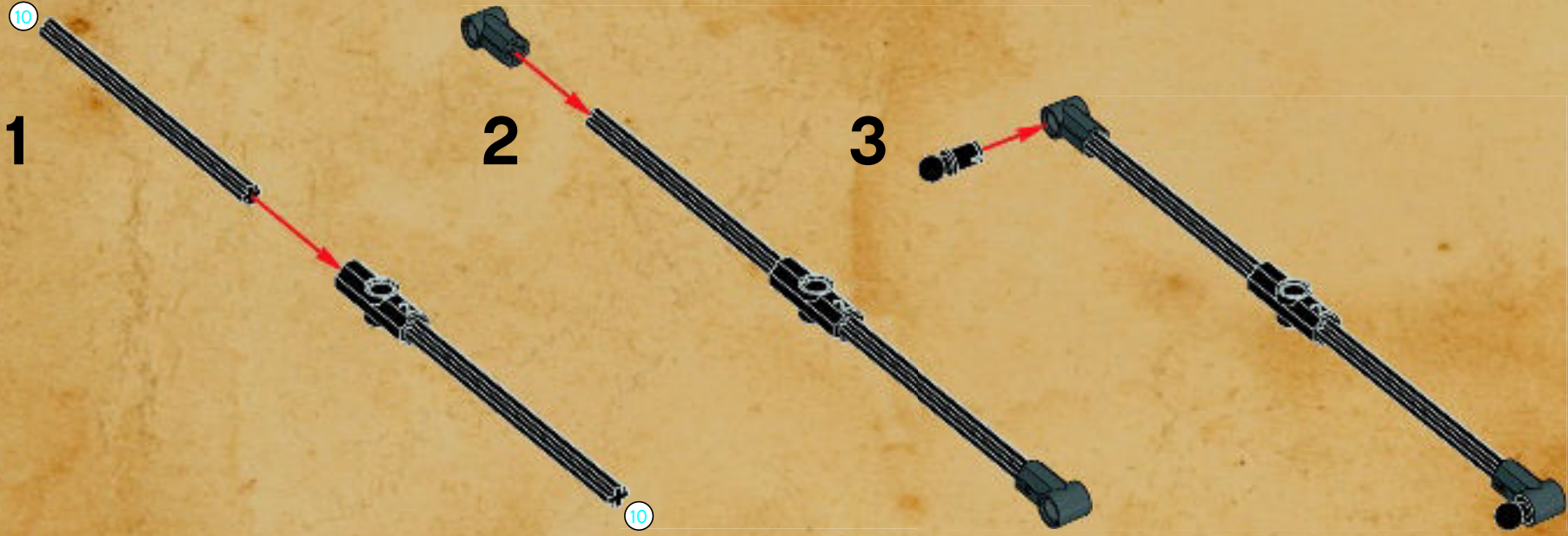



109

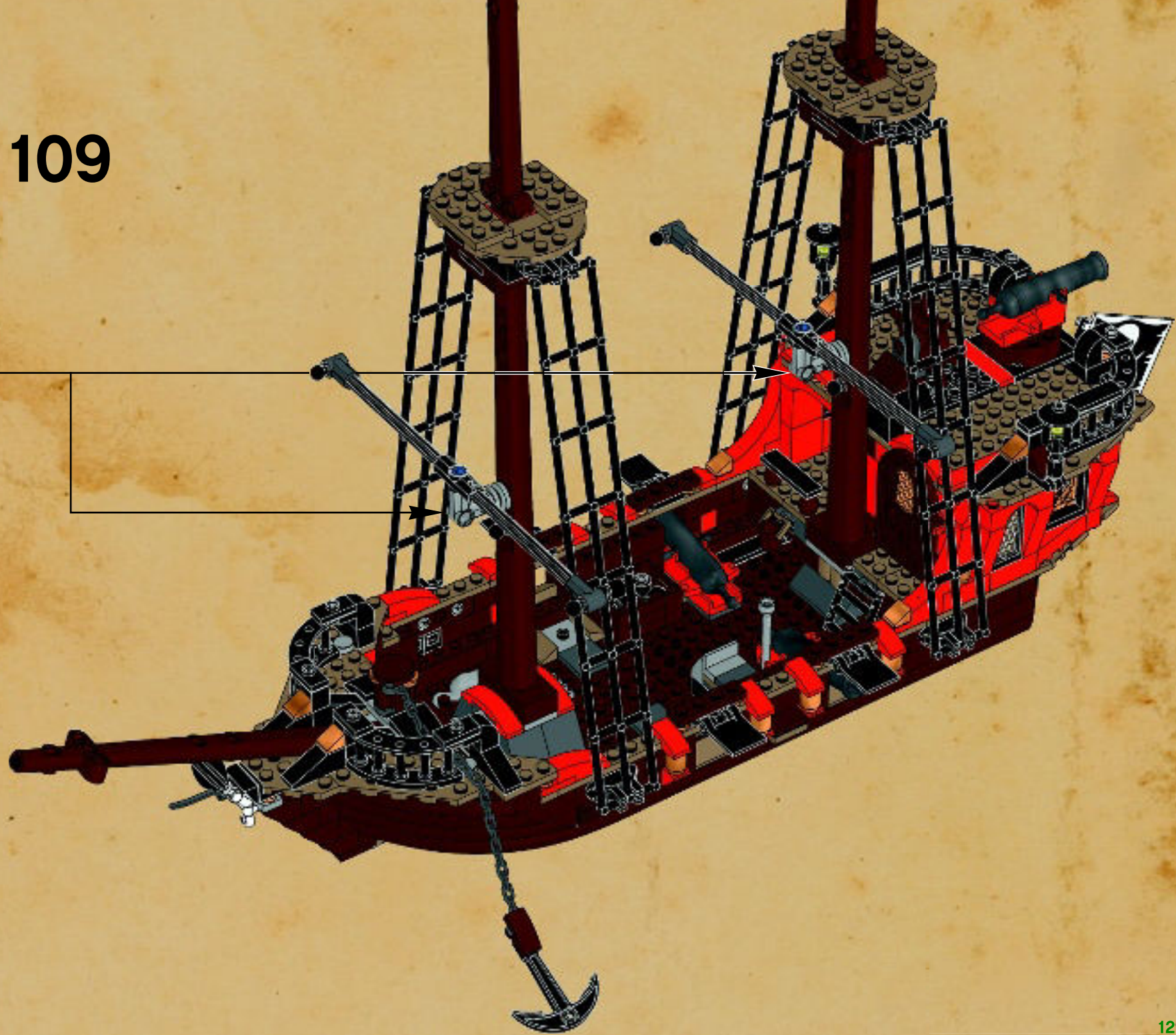



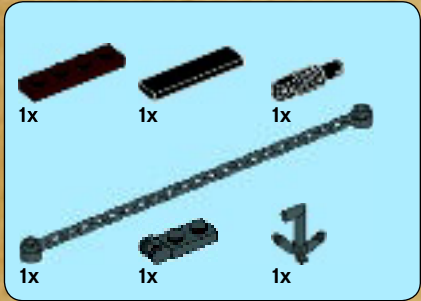

110

1



2





3

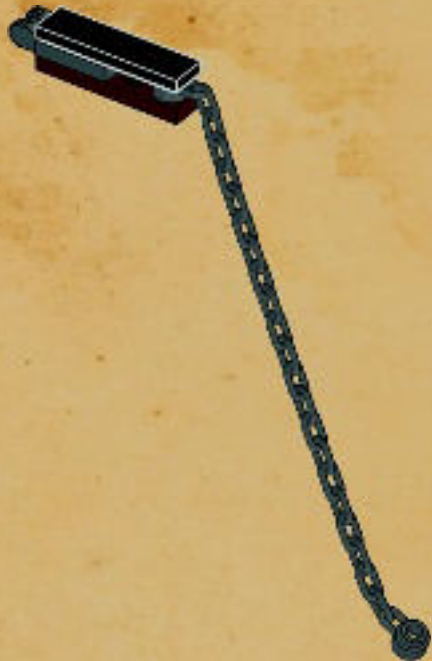

4

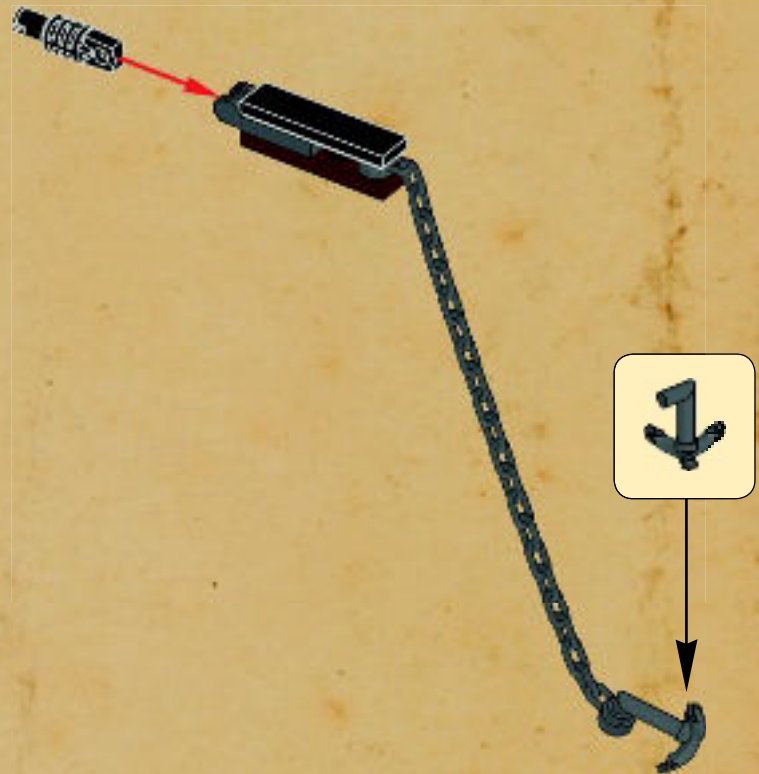



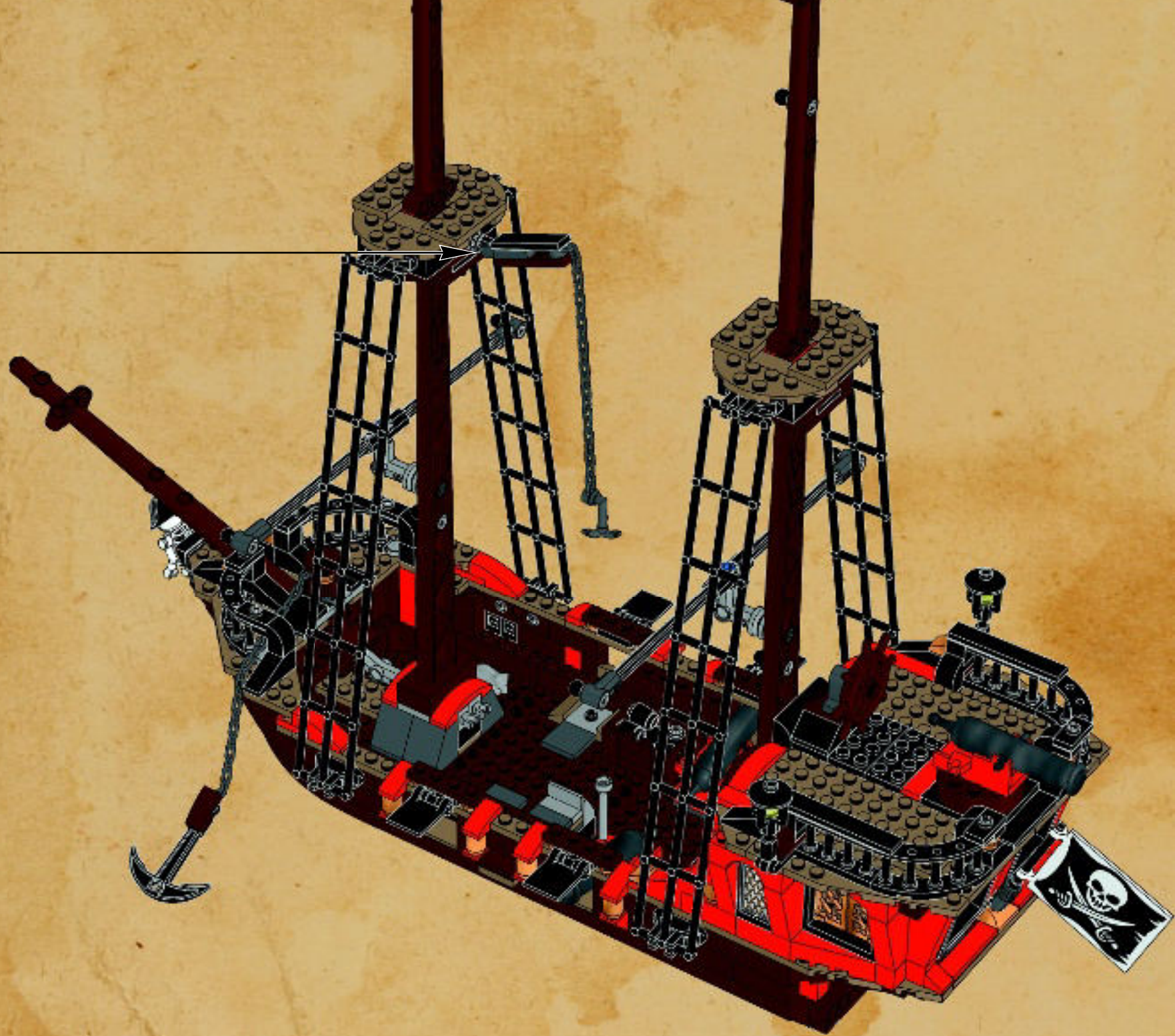



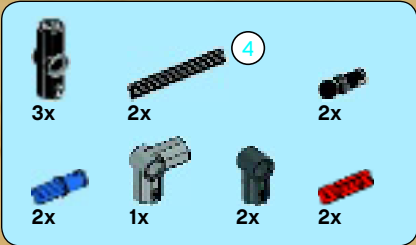

111

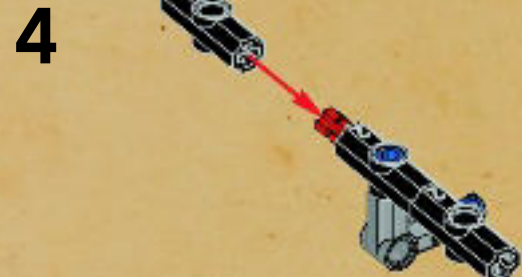
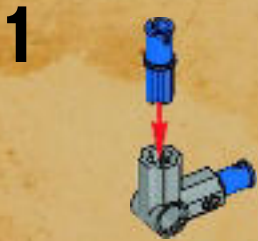



5



6

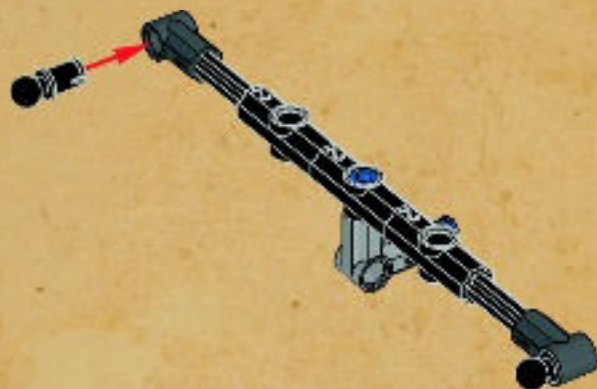



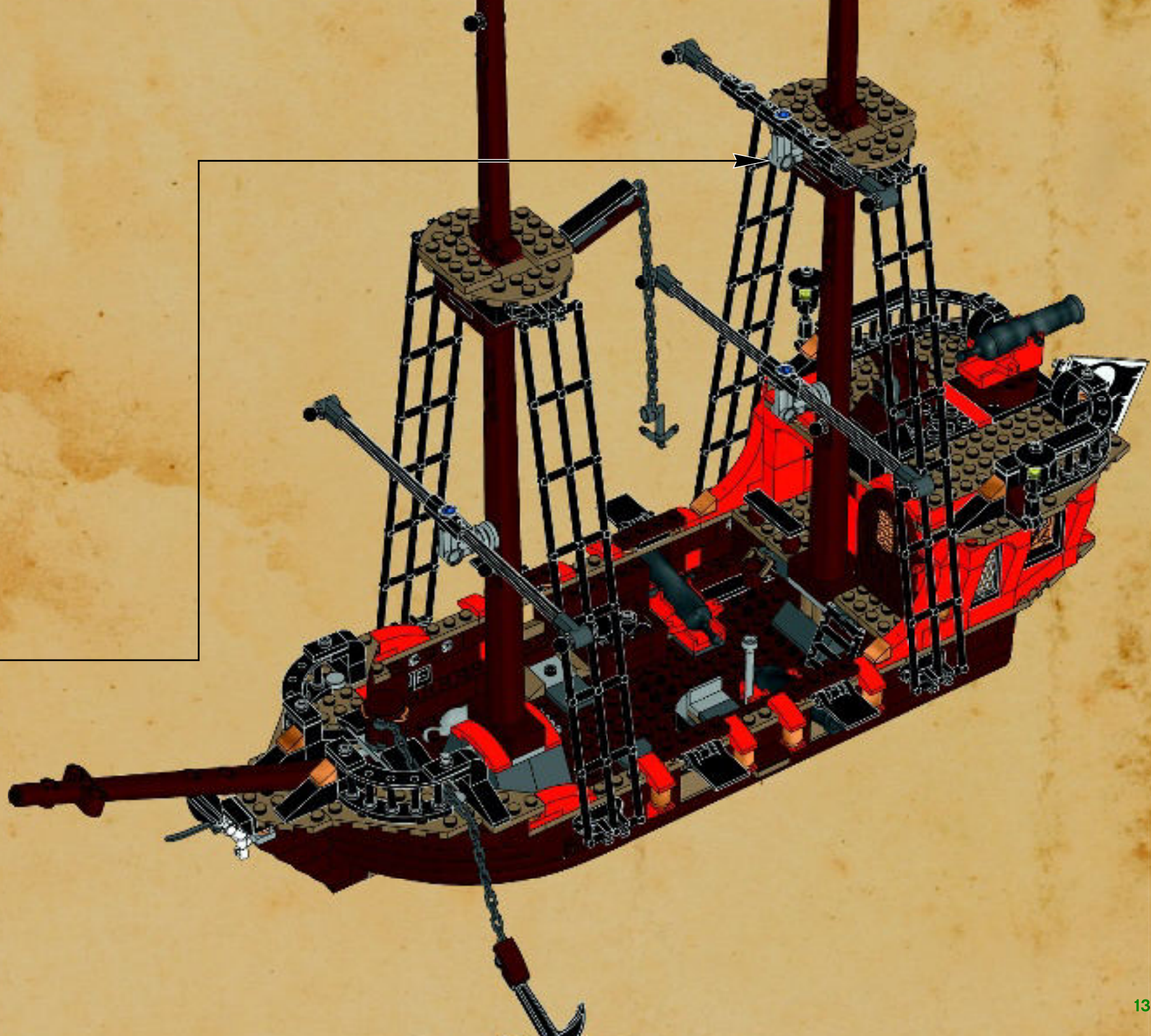





1

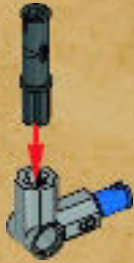

2



3

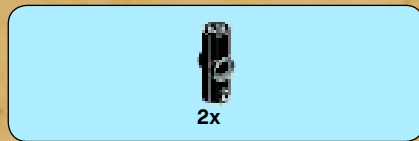
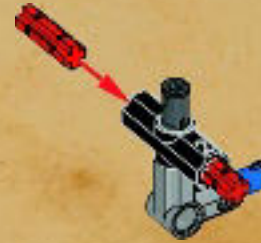

4

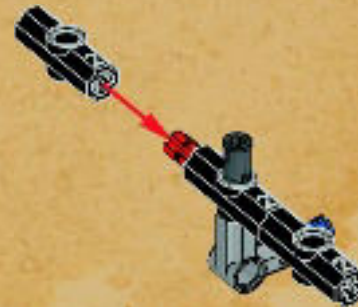



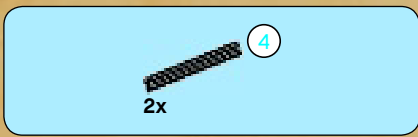

5



6

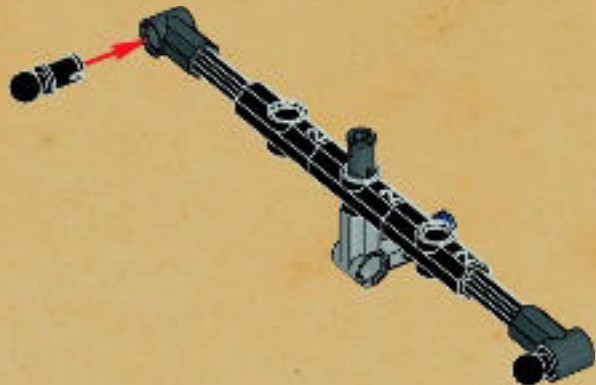

7

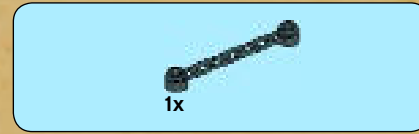
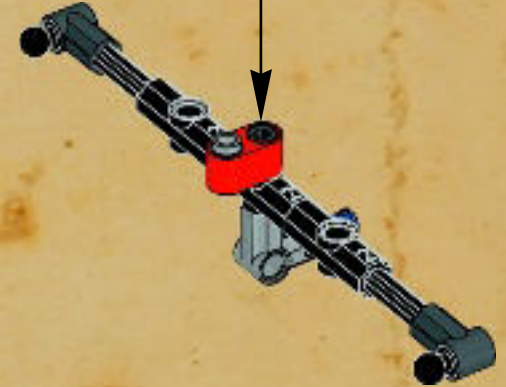

8

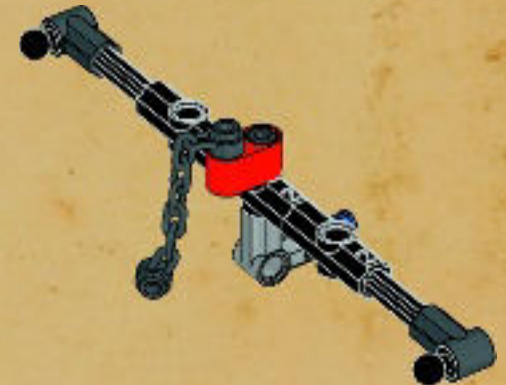



112







4 1:1

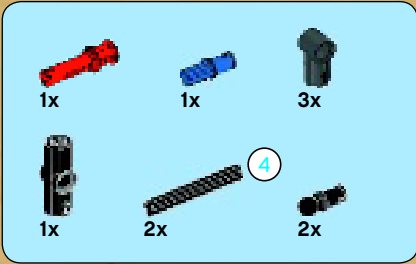

113

1



2



3



4

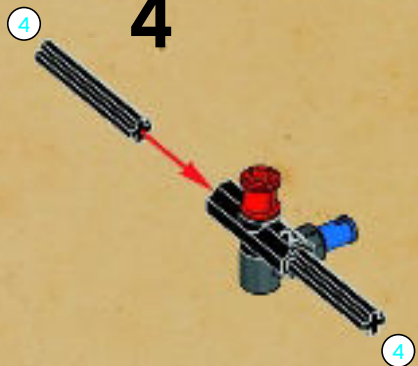



5

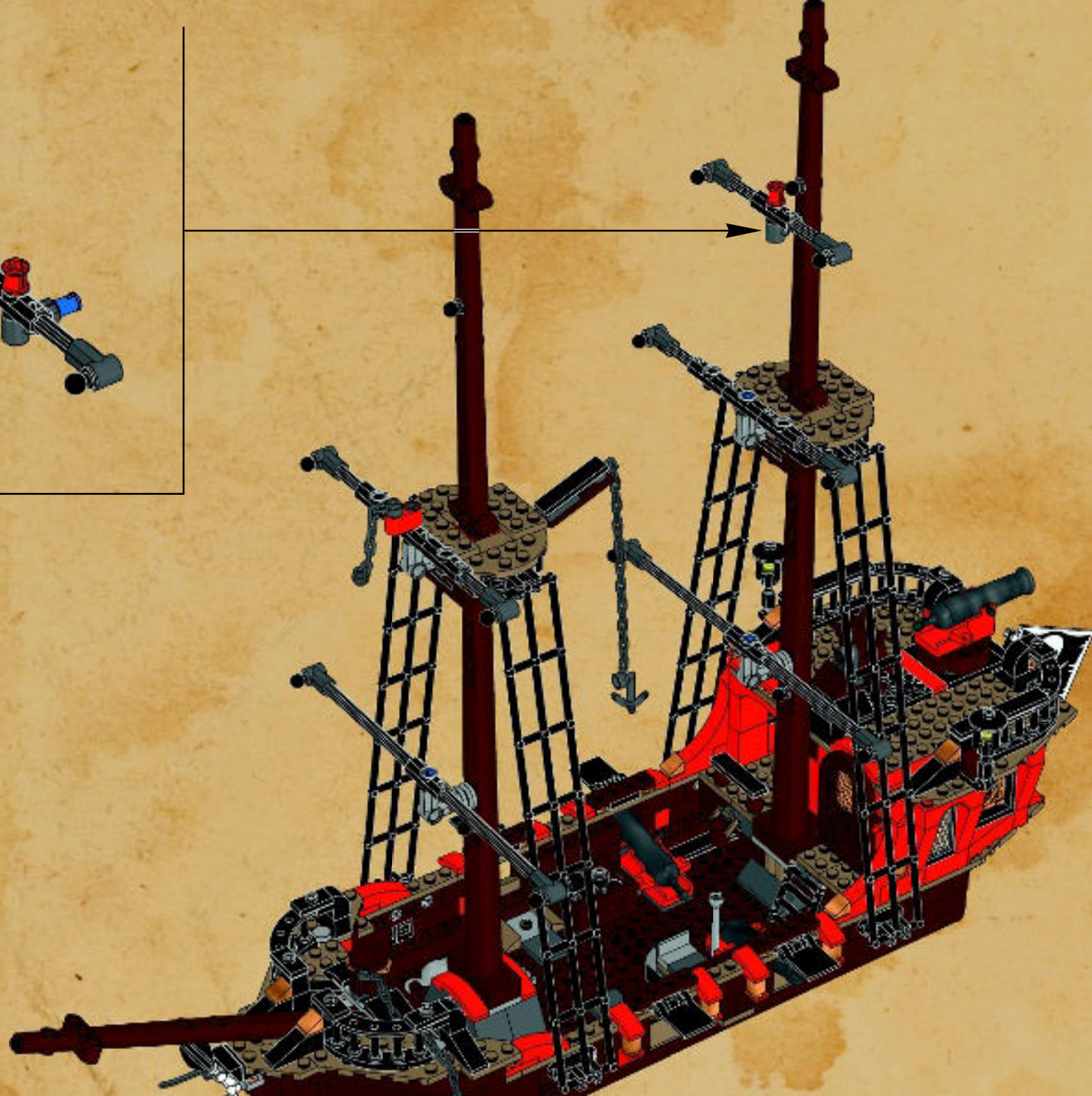
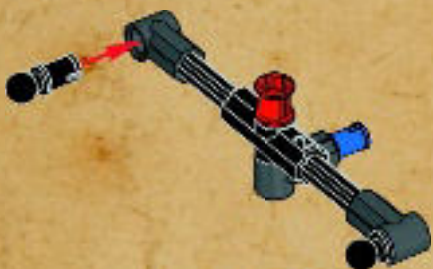





1

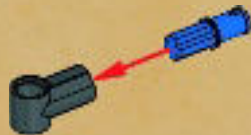

2

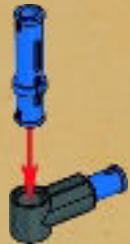

3

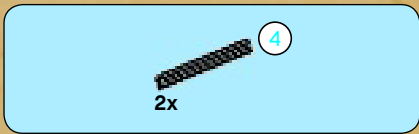

4

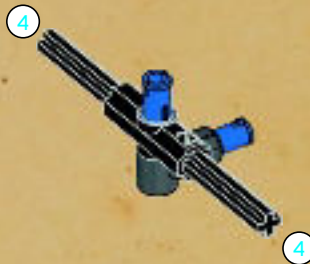



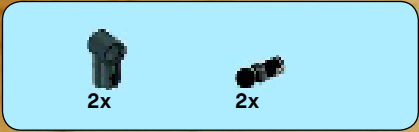

5



6

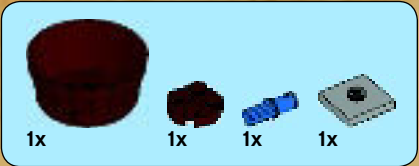
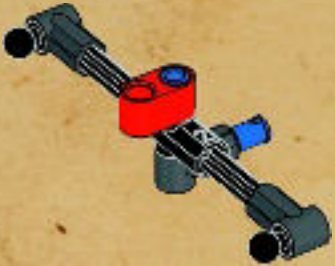

7

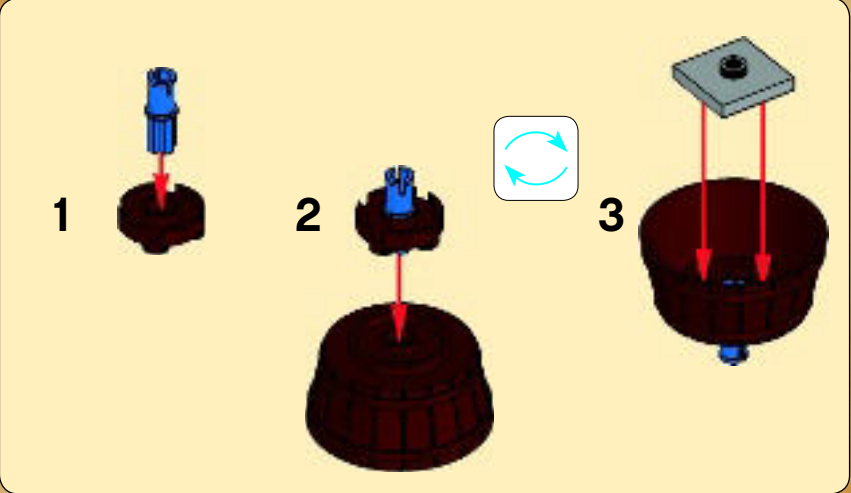



114

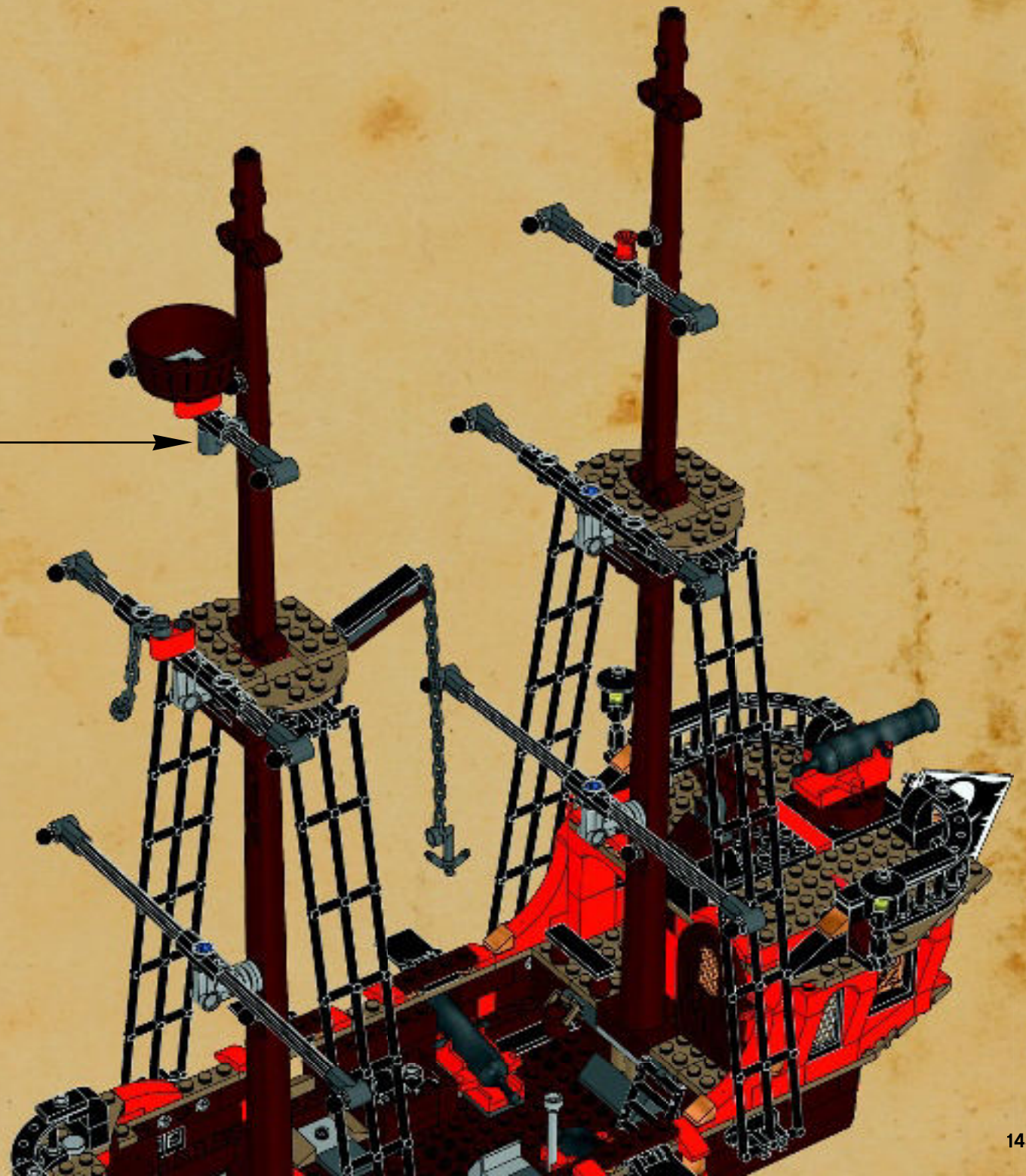



- 1x 
- 1x 
- 1x 
- 1x 

# 115





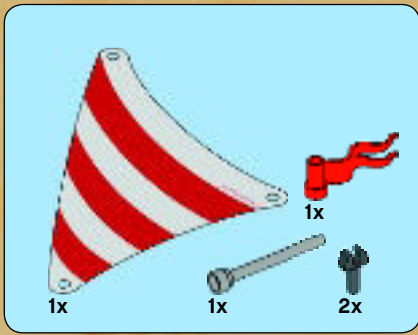

116

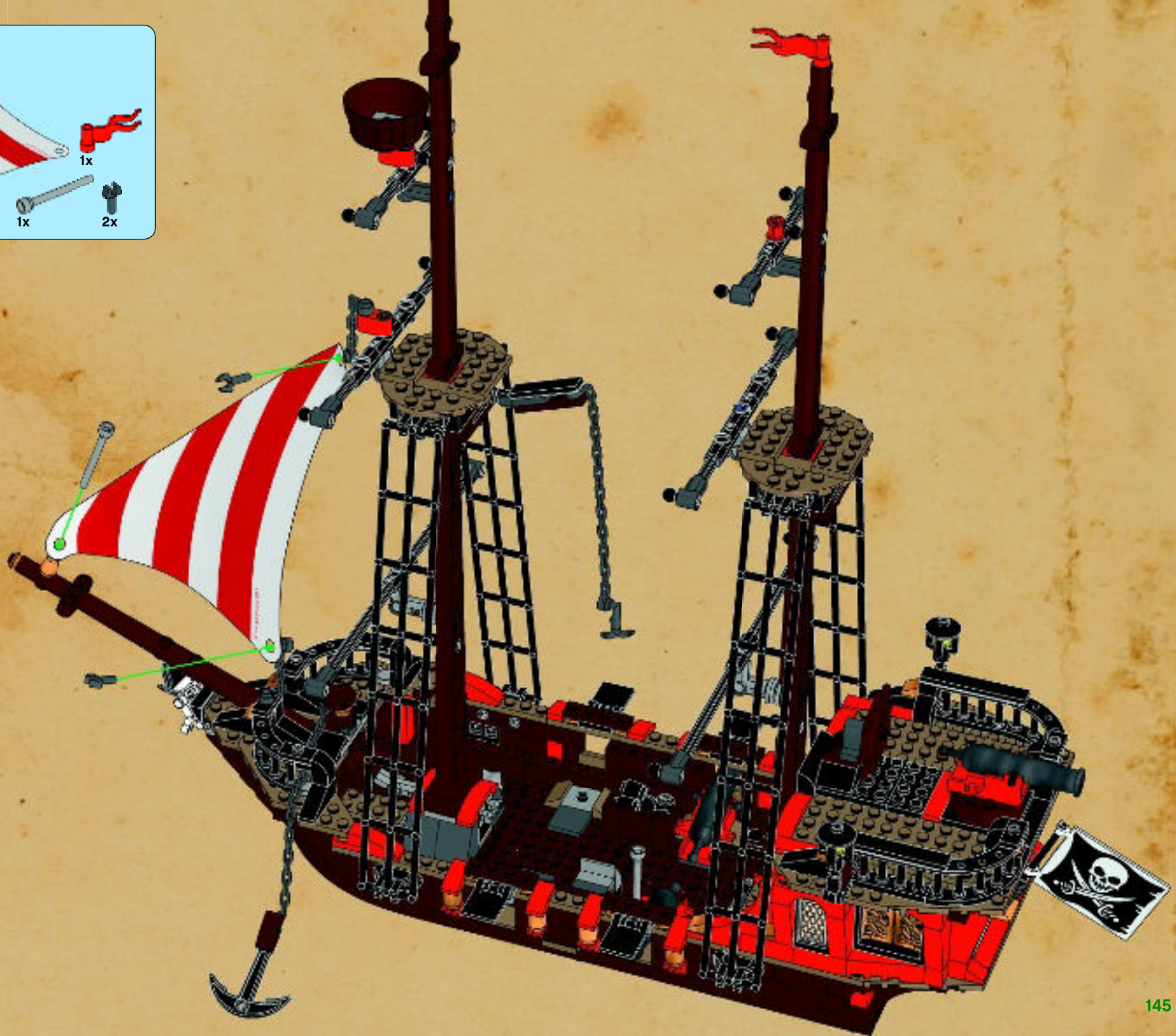





117





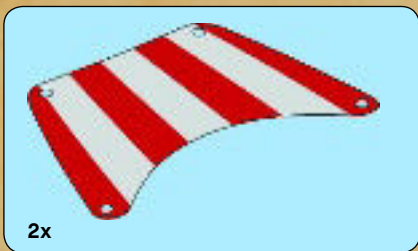

118





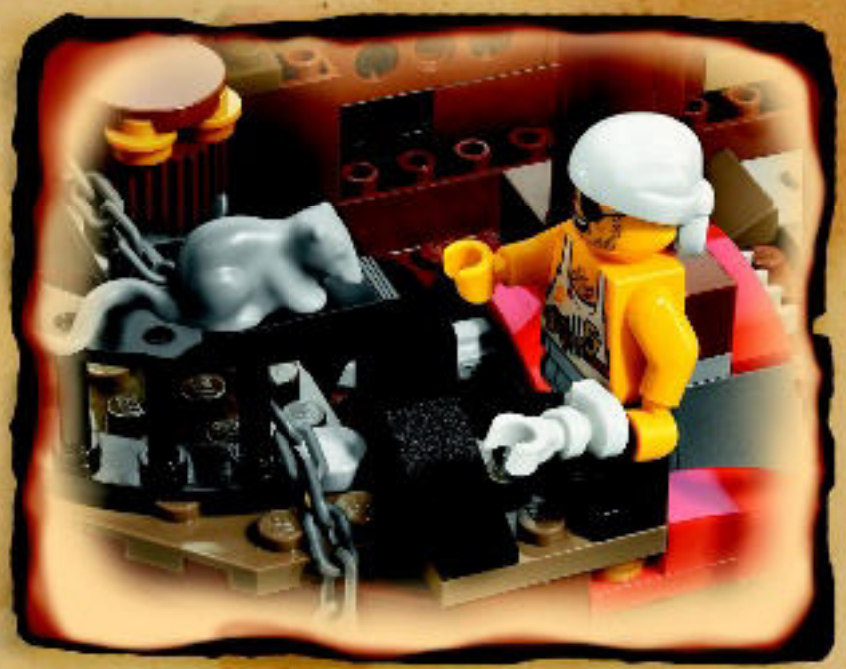



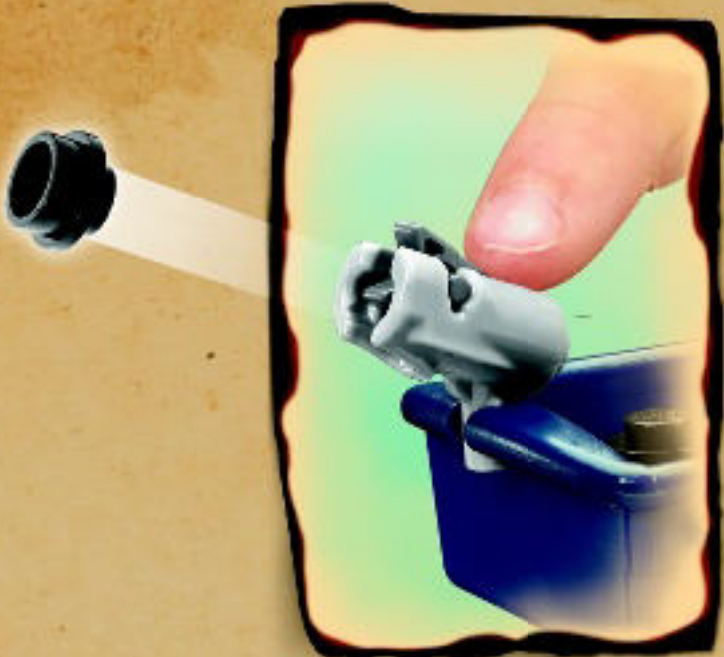



1x  
371001



1x  
6097118



3x  
9327



1x  
6097241



1x  
4651445



1x  
6097475



1x  
6097193



2x  
6038450



2x  
6037870



1x  
4508143



2x  
6096981



1x  
6100077



2x  
6061700



3x  
4143832



2x  
235721



2x  
362221



4x  
300121



1x  
4563682



1x  
6093579

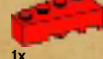

1x  
6093580



2x  
4504379



10x  
366521



10x  
4501534



2x  
4121934



2x  
4195081



8x  
6029946



2x  
4251162



4x  
4633914



2x  
365921



2x  
6093576



6x  
4620762



2x  
302321



5x  
243121



4x  
4612575



1x  
4558212



1x  
449521



1x  
4617549



1x  
4540552



1x  
6097192

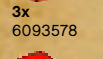

3x  
6093578



2x  
4185664



6x  
4142865



1x  
4140806



6x  
300423



2x  
6099418



9x  
4206482



1x  
4514553



3x  
300324



1x  
6097434



1x  
4584727



1x  
6097291



1x  
4657964



1x  
6097174



1x  
6099703



1x  
4654328



1x  
4506812



4x  
300526



2x  
300126



3x  
300926



4x  
407026



6x  
306226



2x  
4144025



1x  
4548180



2x  
366526



5x  
303926



8x  
428626



6x  
609126



2x  
6053077



1x  
6019726



6x  
6092585



6x  
243126



3x  
302026



3x  
4560182



2x  
663626



4x  
346026



2x  
4550017



1x  
4185620



1x  
6020193



4x  
4140588



2x  
4515368



4x  
614126



9x  
4278359



3x  
474026



2x  
4536522



1x  
4521681



4x  
4530589



4x  
6071335



2x  
6066113



4x  
4294570

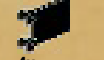

4x  
6011815



1x  
6081988

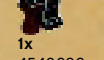

1x  
4540696

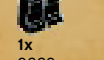

1x  
9339



1x  
6102659

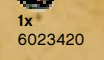

1x  
6023420

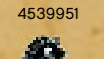

1x  
4539951



1x  
6102651

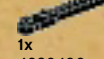

1x  
452826

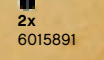

1x  
4620400

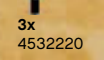

2x  
6015891

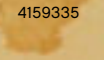

3x  
4532220



1x  
4159335



2x  
393826



1x  
4517986



10x  
4107783



16x  
4184169



6x  
4121715



8x  
4220098



8x  
370526



4x  
373726



2x  
4536998



1x  
4113954



1x  
4119483



5x  
3006844



1x  
4113955



1x  
6020220



1x  
4654448



5x 4520257  
12x 6015449  
6x 4528604  
4x 4496699  
5x 6035540  
2x 4626904  
7x 4267874  
8x 6015424  
3x 4550329  
3x 6006524  
3x 6096215  
1x 6002849  
1x 6002851

1x 6028018  
1x 6028022  
4x 6038637  
4x 6096108  
1x 6035326  
2x 6030845  
1x 4626884  
1x 6097582  
1x 6096286  
4x 4211242  
2x 4211180  
4x 4211200

8x 4211210  
20x 4211220  
3x 4211181  
2x 4216615  
2x 4215496  
10x 4529242  
1x 6036503  
1x 6034334  
2x 6096217  
4x 4267994  
4x 4504376  
4x 6075287  
4x 4211199  
2x 4211202  
5x 4211221

1x 4216625  
2x 6069984  
1x 4658005  
4x 6044725  
2x 4655611  
1x 4221744  
4x 4224243  
4x 4216695  
9x 4211190  
2x 4579690  
2x 4243838  
1x 4211214  
2x 6055145  
1x 6075213

1x 4211159  
1x 4561915  
1x 4541875  
1x 4211163  
1x 4533101  
1x 4211185  
1x 4262974  
1x 6103876  
1x 4622483  
1x 6099520  
1x 4626196  
2x 4609635  
2x 4536847

1x 4211311  
1x 4598713  
3x 6087062  
1x 4548857  
2x 6092409

1x 6085209  
3x 6085211  
1x 6085210



3x  
6061702

2x  
4533772

2x  
4211436

5x  
4211398

3x  
4211350

5x  
4565393

2x  
4211356

1x  
4211395

1x  
4560183

1x  
4211357

1x  
4556157

1x  
4211444

4x  
4650260

1x  
4211515

2x  
4211473

1x  
4512743

1x  
6051333

2x  
4211483

1x  
4211552

2x  
4211758

4x  
4509886

5x  
4211088

1x  
4210935

8x  
4234534

1x  
4211127

6x  
4211052

4x  
4211055

1x  
4210763

2x  
4581225

1x  
4210884

1x  
6086709

1x  
6055313

1x  
6055312

1x  
4217675

3x  
4210789

1x  
6100270

1x  
6044722

2x  
4289542

1x  
4210695

1x  
6051334

2x  
4211066

3x  
4600437

2x  
4516456

14x  
4210658

3x  
6015356

11x  
6060800

1x  
4529247

6x  
4587002

33x  
4523159

1x  
4541895

8x  
4541873

1x  
4538126

2x  
4540700

1x  
4286597

1x  
6058117

3x  
4638950









1x  
6102656



2x  
6102663

2x  
6102667



**Customer Service**  
**Kundenservice**  
**Service Consommateurs**  
**Servicio Al Consumidor**  
**LEGO.com/service or dial**

00800 5346 5555 :        

1-800-422-5346 :  



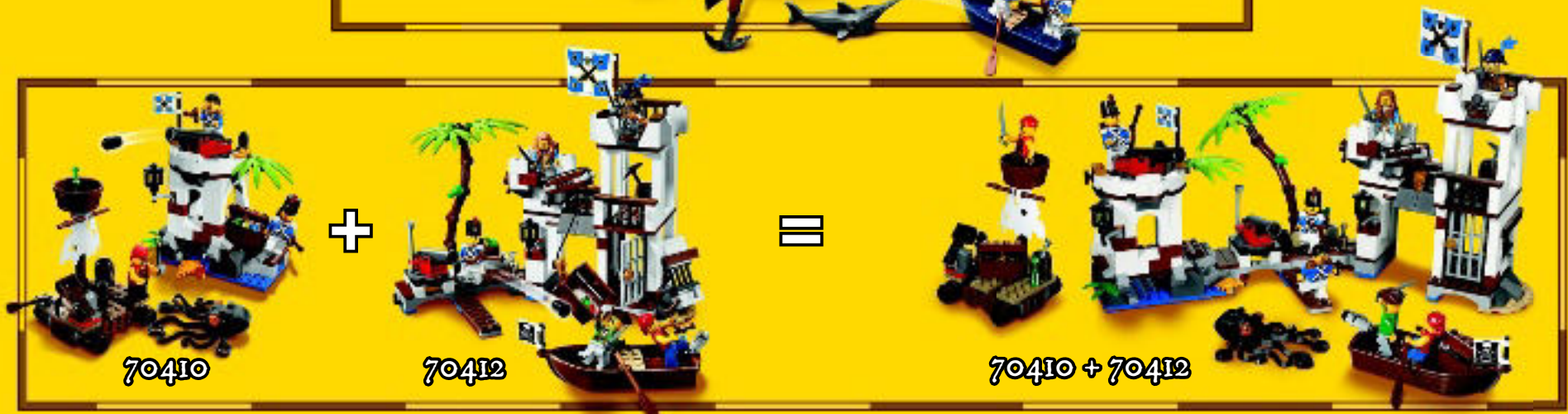
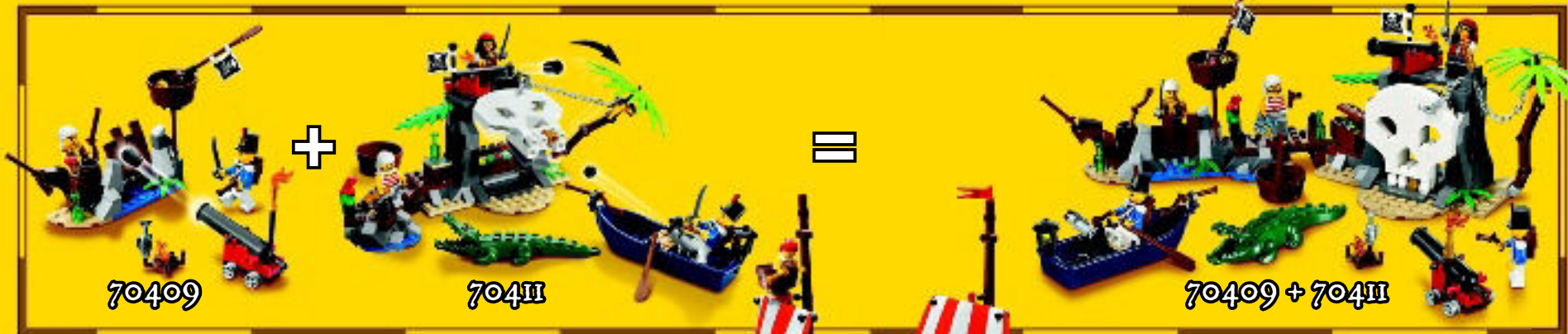





**LEGO**

# minifigures ONLINE

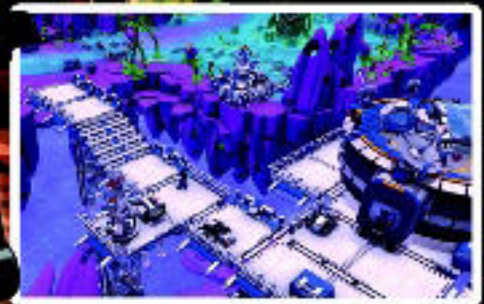

**playminifigures.com**





# club™

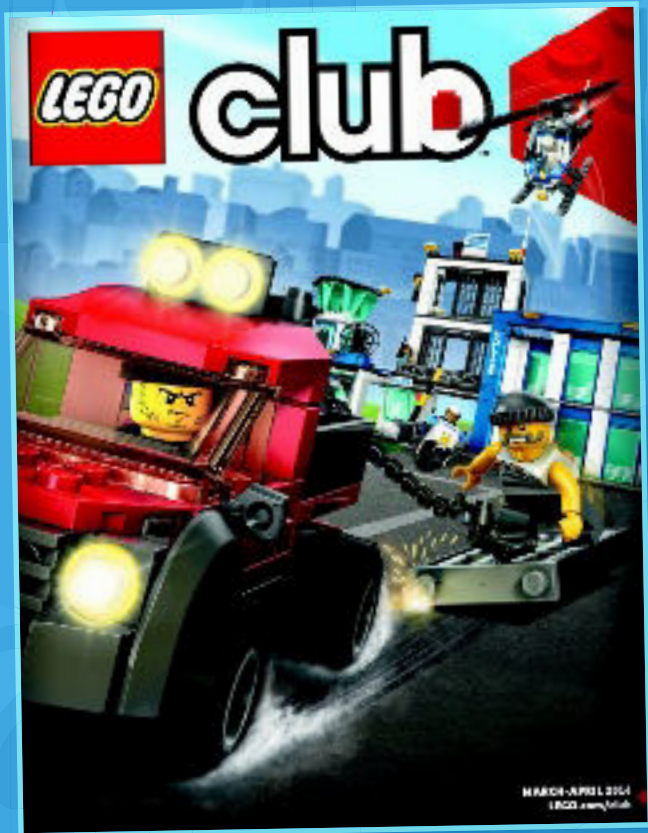



# WIN

GO TO [WWW.LEGO.COM/PRODUCTFEEDBACK](http://WWW.LEGO.COM/PRODUCTFEEDBACK) AND  
GIVE US YOUR SHORT **FEEDBACK** ABOUT THIS  
LEGO® SET FOR A CHANCE TO WIN  
A COOL LEGO PRIZE.



## LEGO.com/productfeedback

### GEWINNE



Erzähle uns auf  
[www.LEGO.com/productfeedback](http://www.LEGO.com/productfeedback)

etwas über die Erfahrungen, die  
du mit diesem LEGO® Set gemacht  
hast, und sichere dir die Chance  
auf einen coolen LEGO Preis!

### GAGNE



Rends-toi sur  
[www.LEGO.com/productfeedback](http://www.LEGO.com/productfeedback)

et donne-nous quelques com-  
mentaires sur ce produit LEGO®  
pour avoir une chance de gagner  
un prix LEGO !

### GANAN



Visita  
[www.LEGO.com/productfeedback](http://www.LEGO.com/productfeedback)

y envíanos tu opinión acerca de  
este set LEGO®. ¡Participarás en el  
sorteo de un premio LEGO!

### 获取奖品



登录  
[www.LEGO.com/productfeedback](http://www.LEGO.com/productfeedback)

给出关于此乐高®套装的简短反馈，  
就有机会获得炫酷乐高奖品

### 경품 당첨 기회



[www.LEGO.com/productfeedback](http://www.LEGO.com/productfeedback)

페이지로 이동하여 이 레고® 세트에  
대한 간략한 피드백을 보내 주시고  
멋진 레고 경품을 탈 수 있는 기회도  
잡으십시오

### ЗАПОЛНИ АНКЕТУ И ПОЛУЧИ ПРИЗ



Перейди по ссылке  
[www.LEGO.com/productfeedback](http://www.LEGO.com/productfeedback)

ответь всего на несколько во-  
просов об этом наборе LEGO®,  
и у тебя появится шанс выиграть  
замечательный приз от компании  
LEGO.